



GOD WAY
GOOD WAY TECHNOLOGY CO., LTD.

3F, No. 135, Ln. 235, Baociao Rd., Sindian Dist., New Taipei City 231, Taiwan

T +886-2-8919-1200

E sales@goodway.com.tw

F +886-2-8919-1220

W http://www.goodway.com.tw

May, 2012

GOD WAY
GoodWay leads you highway



DEVICES

Products Catalog

About Company

Founded in 1983, Good Way owns the expertise in USB and Wireless peripherals and well known for innovative capability as well as being a worldwide leading manufacturer. The complete structure and integration of R&D and sales service supports provide you the excellent solution in product development and technical service. Wherever you are, Good Way is always a reliable business partner as the best backup.

Headquarters/Taiwan

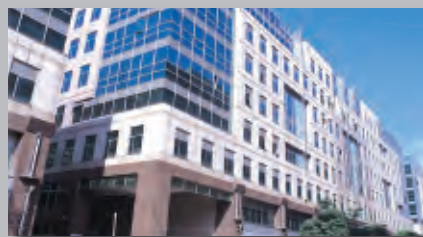

Good Way Technology Co., Ltd. (Taiwan)
3F, No. 135, Ln. 235, Baociao Rd., Sindian Dist., New Taipei City 231, Taiwan.
TEL : +886-2-8919-1200 / FAX : +886-2-8919-1220
Website : <http://www.goodway.com.tw>
E-mail : sales@goodway.com.tw
Functions : Operation headquarters, R&D center

Branch Office/U.S.A.



GWC Technology Inc. (U.S.A.)
365 Cloverleaf Drive Suite D, Baldwin Park, CA 91706 U.S.A
TEL : +1-626-820-0665 / Toll Free : +1-800-699-1529 / FAX : +1-626-820-0949
Website : <http://www.gwctech.com>
E-mail : info@gwctech.com
Functions : Technical Support, Sales

DonG-Guan



Good Way Dong Guan Plant (Don-Guan, China)
No.11, Chuangxing Rd., Shi Tan Pu, Tang Xia Town, Dong Guan City,
Guangdong, China
TEL : +86-769-8685-1123 / FAX : +86-769-8685-1125
E-mail : sales@goodwaytech.com.cn
Functions : Standard Products Manufacturing

Kunshan



Good Way Electronic Co., Ltd. (Kunshan, China)
No. 366, Chang-Jiang N. Rd., Kunshan, Jiangsu, China
TEL : +86-512-5786-0888 / FAX : +86-512-5786-0800
Website : www.goodwaytech.com.cn
E-mail : sales@goodwayks.com.cn
Functions : OEM/ODM Products Manufacturing, R&D Center

One-Stop-Sourcing Time-to-Market

Major Business (OEM/ODM)

Business Support

- We offer the "FSCM" service
 - F means fast, we offer the real-time service and supports
 - S means small, we have more flexibility on quantity issue
 - CM means contract-manufacturing, we are skilled in prototype to volume manufacture
- Time-to-Market
 - Always being sensitive to the latest technology and launching at the right time to the market

Private Labeling / White Box

- One-Stop-Sourcing
 - Comprehensive product range, including PC peripherals, mobile device peripheral, CE merchandise, Home Automation, and industrial connectivity products

Contents

WiFi / Wireless Products	2
Wired Docking Station	5
Cloud Client	8
Network-Enabled Device	10
Versatile Display Adapter	13
DisplayPort Adapter	16
USB Peripherals - USB 3.0	20
USB Peripherals - USB 2.0	26
Charger Devices	28
File Transfer Adapter	30
RF Presenter	32
Digital Audio Device	33
USB Share Switch	34
Adapter & Cable	35



Some products incorporate HDMI® technology.

COPYRIGHT 2012/05 Good Way Technology Co., Ltd. All rights reserved.

- All trademarks and trade names are the properties of their respective owners.
- All specifications and photos here are subjected to change without prior notice.

WiFi/Wireless Products



WK8000

Smart WiFi Media Player

- Full HD 1080P resolution
- Support WiFi Wireless or Ethernet network connection
- Display output (HDMI® or VGA)
- Support DLNA compliant video transmission and Remote desktop mode (PC Mode)
- Compliant with DLNA support smart phone device
- It can connect multi-source like smart phone, NB, Desktop PC, Tablet PC simultaneously but work with one after another
- It can be through wireless HID to do control on PC via TV screen
- Support Windows XP®, Windows Vista®, Windows 7®, Android™ Mac for Smart Phone & Tablet PC

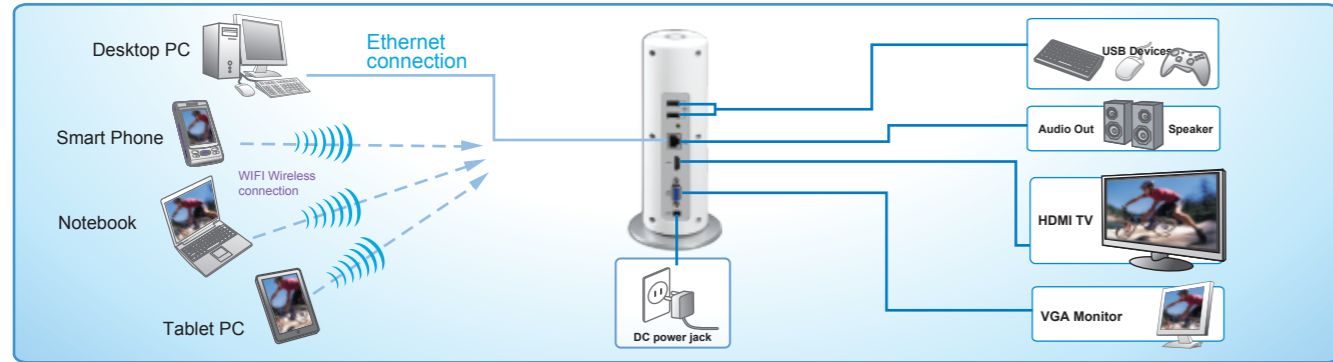

DLNA Audio Box

- DLNA compliant
- 2 CH Audio+3D surrounding for user's selection
- Volume up/down for user's better control
- WiFi connection with 802.11 b/g
- Line out for headset and speaker connection
- Support Windows XP®, Windows Vista®, Windows 7®, Android™ Mac for Smart Phone & Tablet PC
- Support Ad-hoc for linking the device
- Support AP router mode to make users can connect the device and surf internet simultaneously
- Provide USB port to let users listen any music from any USB storage



WA5000



4-port WiFi USB Server



FW2140

- Wirelessly access and share USB devices through your home or office WiFi network
- Supports High-Speed USB 2.0 and backward compatible with USB 1.1
- 10/100/1000Mbps Ethernet port for LAN
- 802.11b/g/n WiFi for wireless LAN
- Centralized remote USB server management
- Centralized remove device status monitoring
- A simple way for multiple users to share USB devices (MFP printer, external hard drives, MP3 Players, flash drives, USB speakers, scanners and more)
- Support Windows XP®, Windows Vista®, Windows 7®

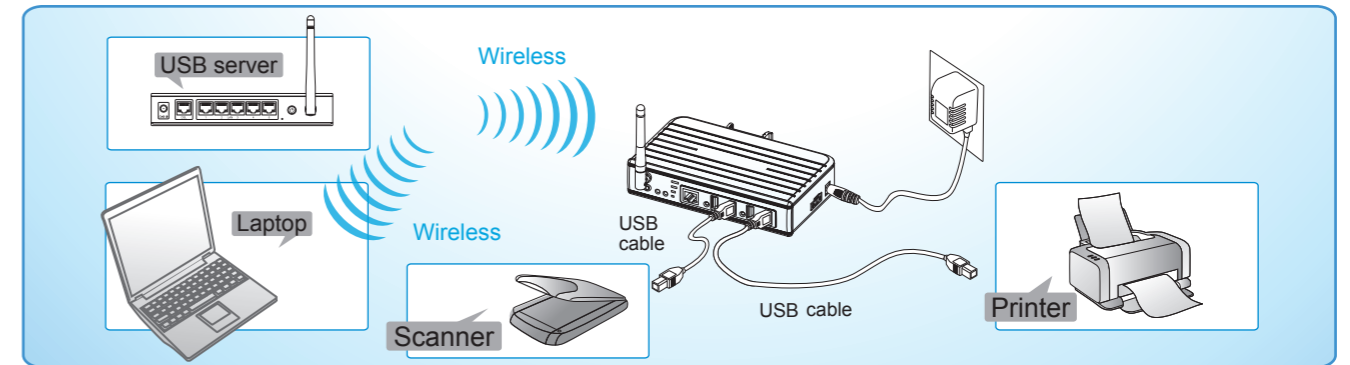

4-port WiFi Serial Device Server



FW2440

- WiFi interface support up to 54Mbps link speed
- Security mode: WEP/WPA/WPA2
- RS-232/422/485 mode selected by S/W
- 15KV ESD immunity to serial interface
- 3KV optical coupling isolation
- 9~36 VDC wide range power input
- Versatile operating mode supported, including RealCOM, TCP Server, TCP Client and UDP
- 10/100/1000 Mbps Ethernet port for LAN
- DIN-rail mountable
- Support Windows XP® (32/64 bits), Windows Vista®, Windows 2000®, Windows Server 2008® (32/64 bits)

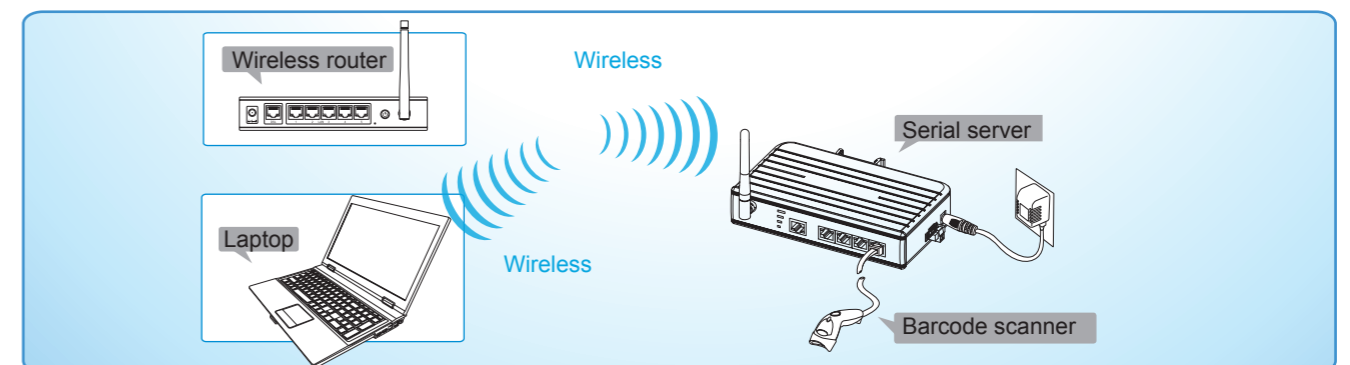



UWB AV Docking Station



WK6102/WK6112

- Wireless connection gives you the freedom to work in comfort anywhere you want within the 10 meters (Max.) range of the docking station
- HDMI HD Support – Through one HDMI port to play 720p high-definition video and digital surround sound on large LCD TV
- Space-saving upright slim design reduces cable clutter on your living room space
- Auto-Installation (For WK6102 Only)
- WiMedia Alliance latest wireless audio/video transmission technology to use
- Supports Windows XP®, Windows Vista®(32/64 bits), Windows 7®(32/64 bits)



Multimedia Sharing from Internet – Can play Youtube film on LCD TV directly through Good Way “UWB AV Docking Station”



Wireless connection from NB to TV – Gives you the freedom to work in comfort anywhere you want within the 10 meters (Max.) range of the docking station

HDMI® HD Support – Through HDMI® port to play high-definition video and digital surround sound on LCD TV

Wired Docking Station

USB 3.0 Docking Station



DU3000

- Display: Single DVI-I Output
- Provide USB 3.0/2.0 ports for users better selection
- Resolution up to 2048 x 1152
- Support Audio Headphone and microphone
- Support Gigabit Ethernet
- Compatible with USB 3.0/2.0 Specification upstream connection
- Support Windows XP®, Windows Vista® (32/64 bits), Windows 7®(32/64 bits)

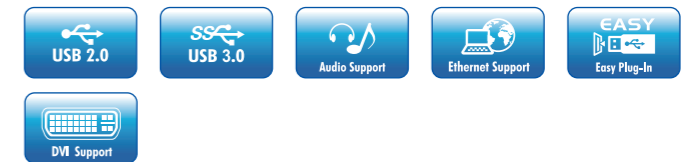

USB 3.0 Dual Head Docking Station



DU3200

- Dual Display Output : HDMI® v1.3 and DVI-I
- Compatible with USB3.0/2.0 Specification
- Support Gigabit Ethernet
- Resolution up to 2048 x 1152
- Support Audio 2.1 channel
- Support Windows XP®, Windows Vista® (32/64 bits), Windows 7®(32/64 bits)





DH2000

High-Definition A/V Docking Station

- DualView let you expand your work area across your notebook screen and external monitor
- HDMI monitor output - Supports video resolutions up to 1920 x 1080 Full HD monitor
- One forward-facing USB 2.0 port - Ideal for use with memory keys and other "quick access" devices
- Supports Windows XP®, Windows Vista®(32/64 bits), Windows 7®(32/64 bits),



DU27A2
DU2792

Docking Station with Audio/Video

- DualView let you expand your work area across your notebook screen and external monitor
- DVI monitor output - Supports video resolutions up to 1920 x 1080 Full HD monitor(for DU2792)
- DVI monitor output - Supports video resolutions up to 2048 x 1152 Full HD monitor(for DU27A2)
- Integrated 10/100M Ethernet - For Internet / LAN connectivity. No external adapter required
- Supports Windows XP® (32 bit), Windows Vista®, Windows 7®



DU2800

Mini Docking Station

- DualView let you expand your work area across your notebook screen and external monitor
- DVI monitor output - Supports video resolutions up to 1920 x 1080 Full HD monitor
- Four USB 2.0 ports - Ideal for most USB devices, including printers, keyboards, and mice
- Integrated 10/100M Ethernet - For Internet / LAN connectivity. No external adapter required
- Supports Windows XP®(32 bit), Windows Vista®, Windows 7®



DU24A0

High-Speed USB 2.0 Docking Station

- Four spaced USB 2.0 ports allow you to connect multiple USB devices such as printer, external Hard Drive
- 10/100 Ethernet port allows you to maintain an Internet connection and avoid wireless hang-up
- Stereo output port allows connection of stereo or 2.1 speaker systems
- RS-232 serial ports - allow you to connect to serial devices such as touch screens and barcode scanners
- Supports Windows XP®, Windows Vista®, Windows 7®



DU2810

Mini Docking Station

- Build-in Auto-install function (installation CD not requires) suitable with Netbook or without CD-ROM devices user
- DualView let you expand your work area across your notebook screen and external monitor
- DVI monitor output - Supports video resolutions up to 1920 x 1080 Full HD monitor
- Six USB ports make connections quick and easy
- Supports Windows XP®(32 bit), Windows Vista®, Windows 7®

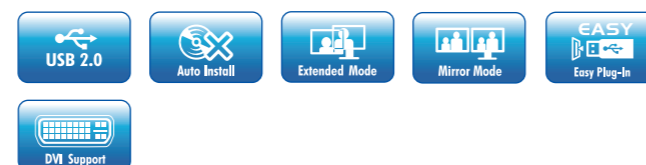

HE2440

Portable Mini Docking Station

- Four spaced USB 2.0 ports allow you to connect multiple USB devices such as printer, external Hard Drive
- Integrated 10/100M Ethernet - For Internet/LAN connectivity
- Power by USB port. No external power adapter required
- Supports Windows XP®, Windows Vista®, Windows 7®, Mac®



Cloud Client



ZC2600 (DU2600)



ZC2610

Client Dock

- Extend display up to 12 m from the computer
- Bus power active
- Support Video resolution up to 1280 x 1024, 1440 x 900 (wide screen)
- Audio ports to connect to 2.1 stereo speaker and MIC
- Distribution to 12 display screens
- Compatible with USB 1.1/2.0 Specification
- Support Universal VESA Mount Bracket
- Support Windows® MultiPoint® Server 2011 & CAL license available
- Support Useful MultiSeat Linux 2011™ & CAL license available

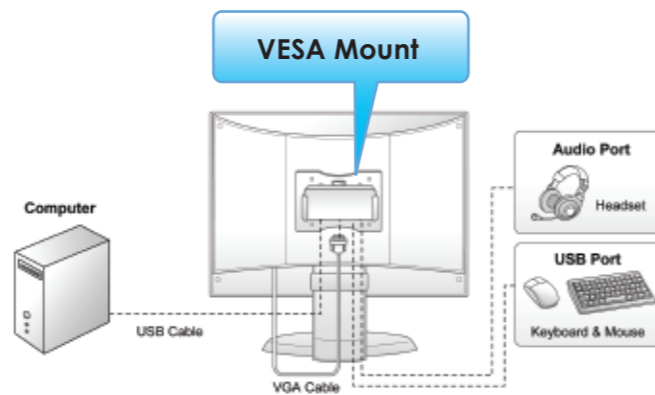

Cloud Client USB Docking

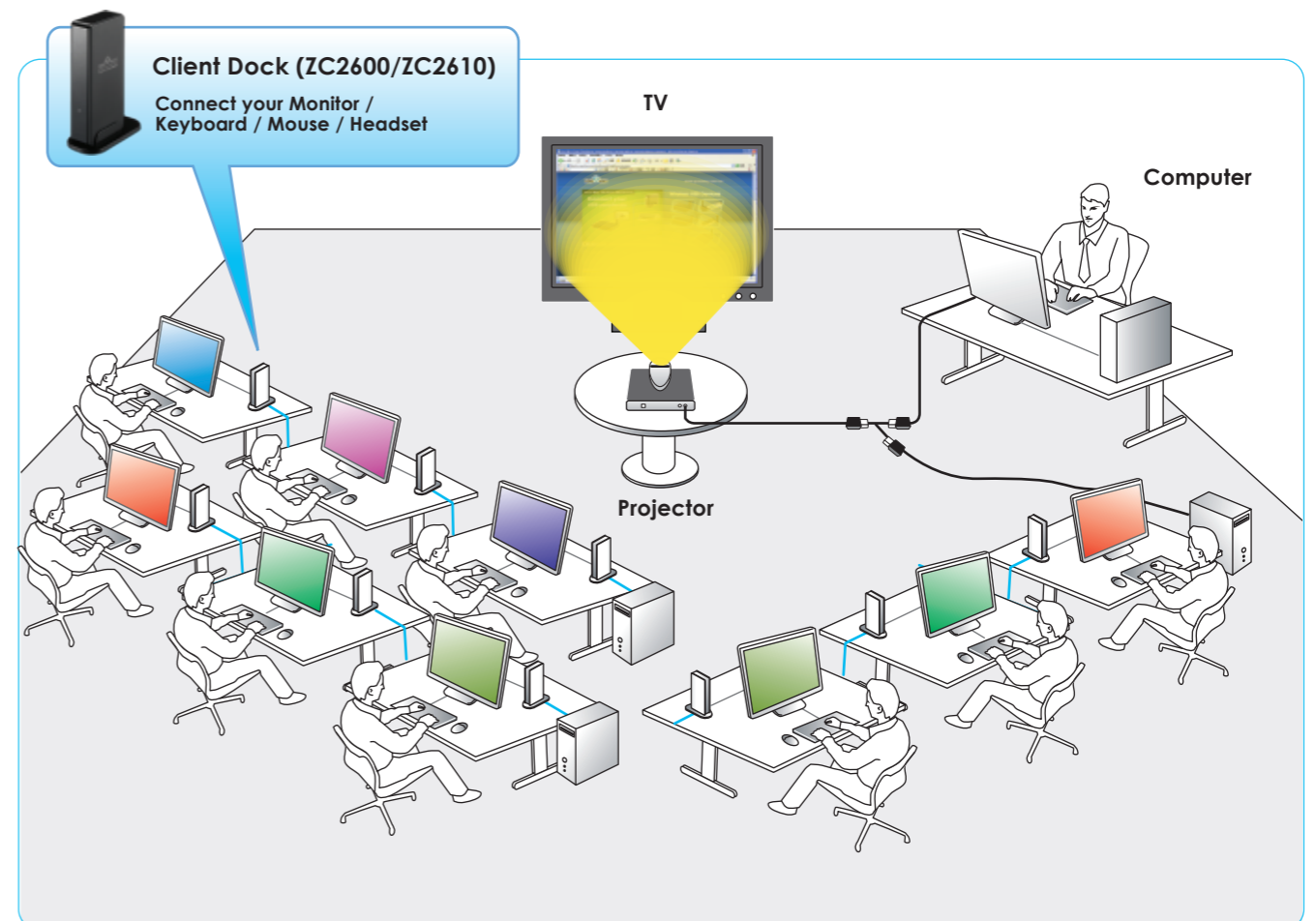
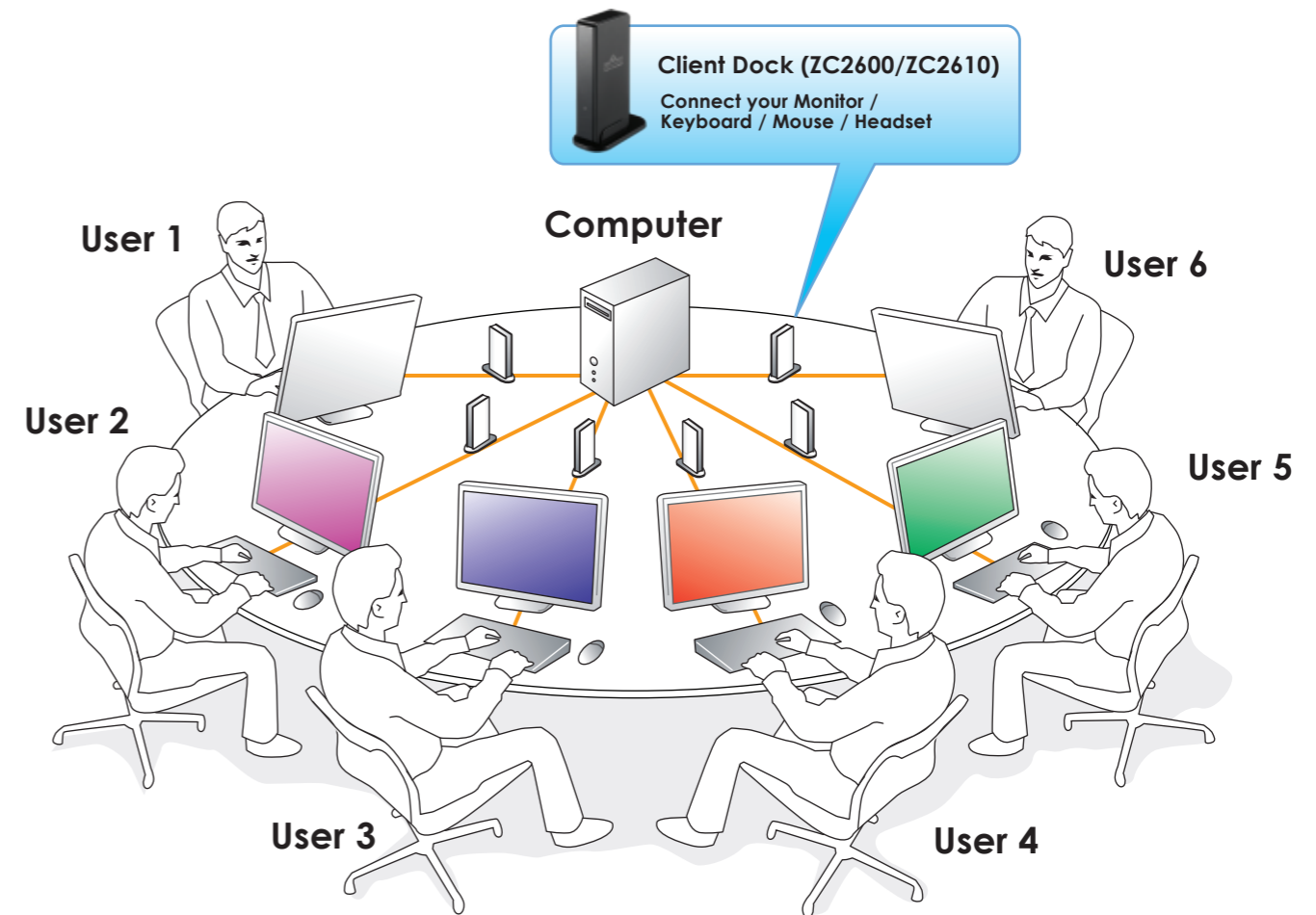
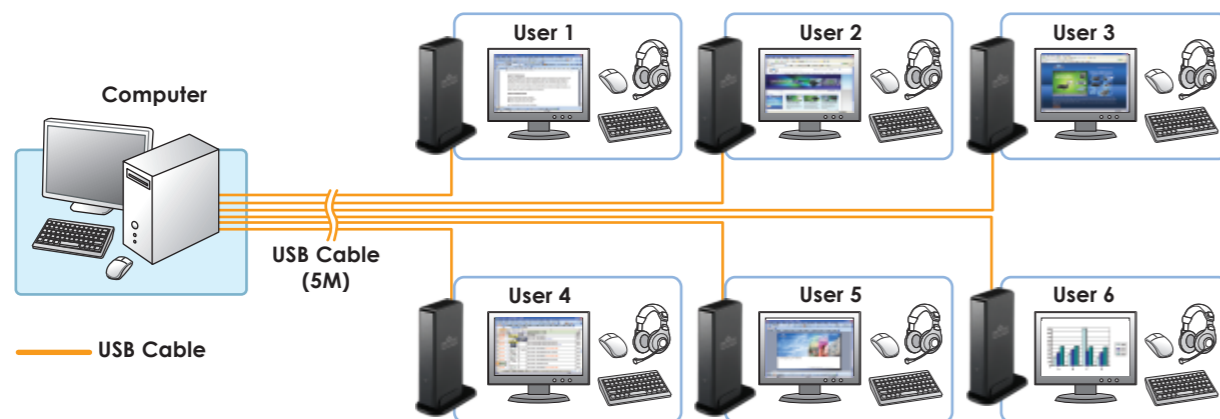

Network-Enabled Devices



Gigabit Ethernet to HDMI® Adapter

- Compatible with Gigabit Ethernet specification
- Video applications on LCD monitor or projector shared through Gigabit Ethernet port
- HDMI® monitor output - Supports video resolutions up to 1080p Full HD monitor
- Transmission HD 1080p video and digital surround sound via one HDMI® port
- Long transmission distance up to 100 meters
- AE6100 supporting feature Client Dock, Net KVM Adapter & A/V Adapter
- Supports Windows XP®, Windows Vista® (32 bit), Windows 7®, Windows® MultiPoint™ Server 2011



AE6100A1: Client Dock (Multi-User)
 AE6100A2: Net KVM (Multi-Server)
 AE6100A3: AV Adapter (Multi-Monitor)



Gigabit Ethernet to DVI Adapter

- Compatible with Gigabit Ethernet specification.
- Video applications on LCD monitor or projector shared through Gigabit Ethernet port.
- DVI video resolution can be supported up to 1920 x 1080.
- Audio ports let you connect 2.1 stereo speakers.
- Long transmission distance up to 100 meters
- AE6210 supporting feature Client Dock, Net KVM Adapter & A/V Adapter
- Supports Windows XP®(32 bit), Windows Vista®, Windows 7®, Windows® MultiPoint™ Server 2011



AE6210A1: Client Dock (Multi-User)
 AE6210A2: Net KVM (Multi-Server)
 AE6210A3: AV Adapter (Multi-Monitor)

Net KVM

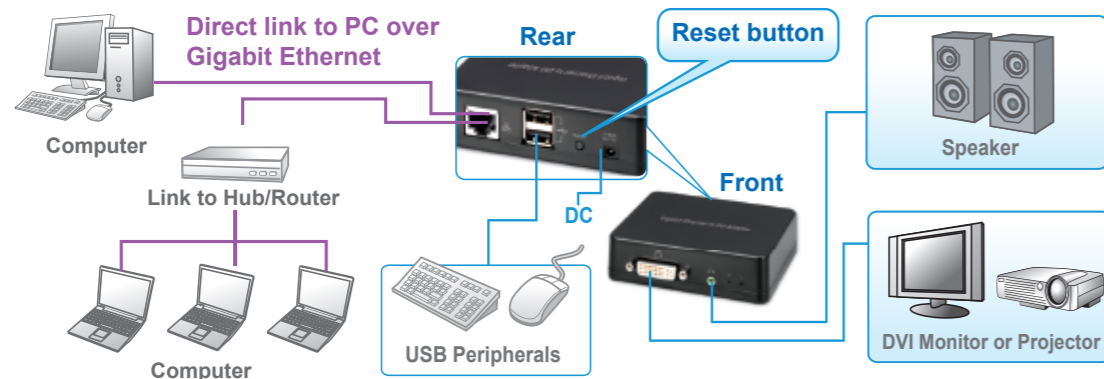

Cloud Client Gigabit Ethernet Adapter

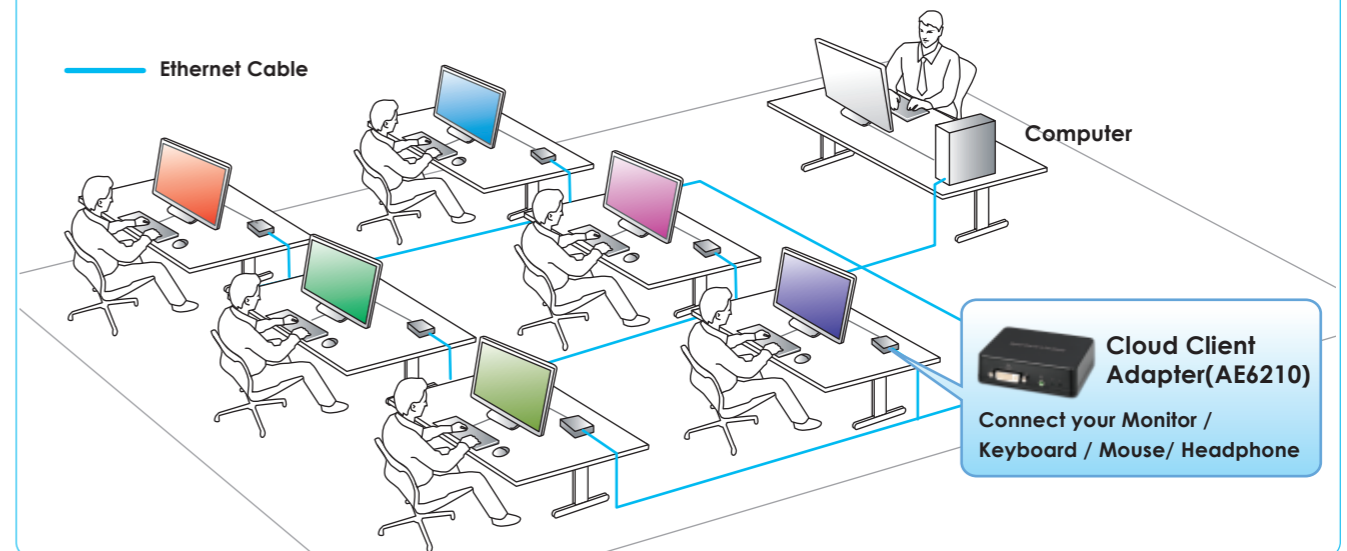

Digital Signage Distribution Adapter

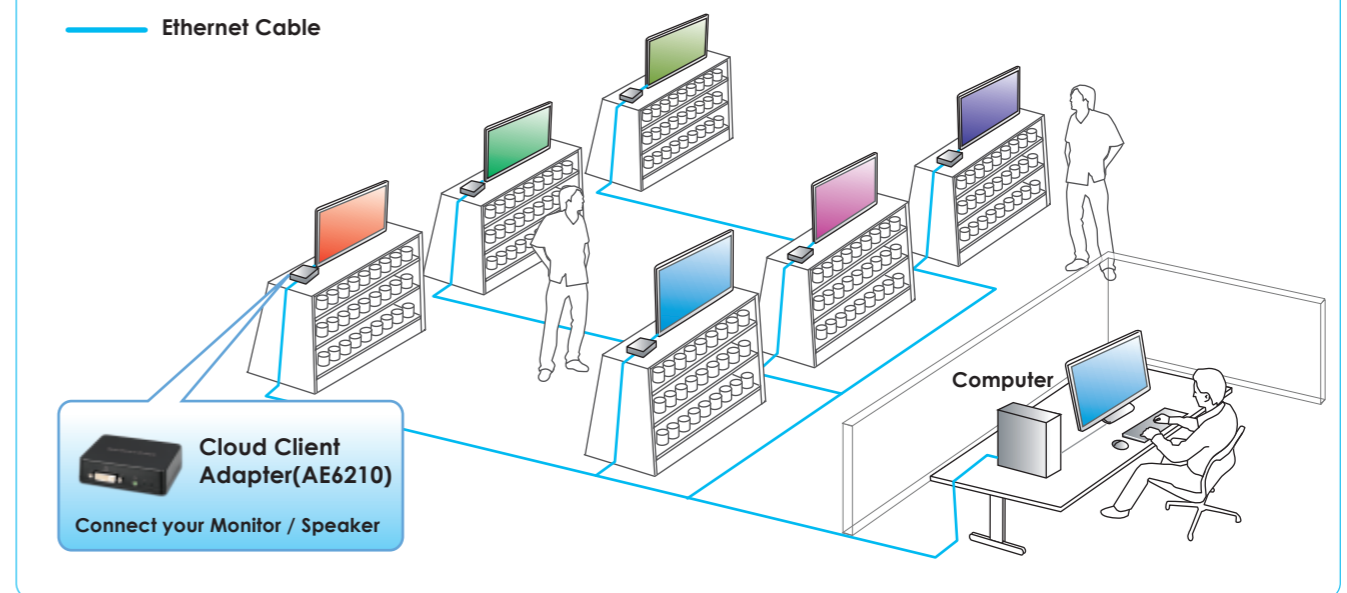

USB 3.0 to Gigabit Adapter



AE3302

- USB3.0 to 10/100/1000 Mbps Gigabit Ethernet
- Support all USB 3.0 power saving models
- Support Wake-on-Lan function
- Support Green Ethernet
- Support IEEE 802.3az(Energy Efficient Ethernet)
- Support IPv4/IPv6 packet Checksum Offload Engine(COE) to reduce CPU loading
- Supports Windows XP®, Windows Vista® and Windows 7®, Mac®





USB 2.0 Ethernet Adapter

- Compliant with USB 2.0 and USB 1.1 specifications
- Compliant with IEEE 802.3 (10Base-T) and 802.3u (100Base-TX) standards
- Supports both full-duplex and half-duplex operations
- Supports suspend mode and remote wakeup via link-up and magic packet
- Powered by USB port only
- Equipped with diagnostic LEDs
- Ultra Low power consumption
- With Light CPU loading
- IBM compatible Pentium-233MHz or faster PC or Mac
- Supports Windows XP®, Windows Vista®, Windows 7®, Mac®



A-Type USB AE2220
A-Type USB AE2230
Mini USB AE2240
Micro USB AE2250
(Support Wii™)



Versatile Display Adapter



USB 3.0 Dual Head Display Adapter

- Compliant with USB 3.0/2.0 specification upstream connection
- Resolution up to 2048 x 1152
- Dual head display with HDMI® and DVI-I output
- Support HDMI® v1.3
- Support Windows XP®, Windows Vista® (32/64 bits), Windows 7® (32/64 bits)



AN3200



USB 2.0 Ethernet Adapter

- Compliant with USB 2.0 and USB 1.1 specifications
- Compliant with IEEE 802.3 (10Base-T) and 802.3u (100Base-TX) standards
- Supports both full-duplex and half-duplex operations
- Supports suspend mode and remote wakeup via link-up and magic packet
- Supports Windows XP®, Windows Vista®, Windows 7®, Mac®



AE2201



Gigabit USB 2.0 Ethernet Adapter

- Supports 10/100/1000 Mbps auto-sensing capability
- Supports Auto MDIX (straight and cross network cable auto-detection)
- USB specification 1.0, 1.1 and 2.0 compliant
- Supports USB full and high speed modes with bus power capability
- IEEE 802.3, 802.3u, and 802.3ab (10Base-T, 100Base-TX, and 1000Base-T) compatible
- Supports Windows XP®, Windows Vista®, Windows 7®, Mac®



AE2302



Gigabit USB 2.0 Ethernet Adapter

- Supports 10/100/1000 Mbps auto-sensing capability
- Supports Auto MDIX (straight and cross network cable auto-detection)
- USB specification 1.0, 1.1 and 2.0 compliant
- Supports USB full and high speed modes with bus power capability
- IEEE 802.3, 802.3u, and 802.3ab (10Base-T, 100Base-TX, and 1000Base-T) compatible
- Supports Windows XP®, Windows Vista®, Windows 7®, Mac®



AE2300



USB 3.0 Display Adapter

- Add-on monitor, LCD or projector through different display output
- Compliant with USB 3.0 Super Speed (Data Rate 5Gbps)
- Maximum resolution support : 2048x1152 / 2560x1600 (DP only) pixels
- Variety of display output interface including VGA / DVI / HDMI® / DP
- Plug & Play
- Supports Windows XP(32 bit)®, Windows Vista®, Windows 7®



AN3410
(2048x1152)



AN3420
(2048x1152)



AN3810
(2048x1152)



AN3820
(2560x1600)



AN2820

USB 2.0 to HDMI® Adapter

- Add-on monitor, LCD or projector through a single USB 2.0 port
- Hot-plug; add or remove monitor without system reboot
- Small in size, works with all HDMI® displays
- Supports high resolution support : 1920 x 1080 pixels
- Extend and Mirror mode support
- Resumes from hibernation and suspend modes
- Supports up to 6 USB display adapter to work simultaneously
- Support Over Scan function
- Supports Windows XP®, Windows Vista®(32/64 bits), Windows 7®(32/64 bits), Mac 10.4



AN2800



AN2450
(2048 x1152)
AN2460
(1920 x1080)



AN2480
(1920 x1080)



AN2485
(1920 x1080)



USB 2.0 Display Adapter

- Add-on monitor, LCD or projector through a single USB 2.0 port
- Compliant with USB 2.0 High Speed (Data Rate 480 Mbps)
- Maximum resolution support : 1920x1080 / 2048x1152 pixels
- Maximum 6 USB display adapters could be working simultaneously on one platform
- USB bus-powered
- Resumes from hibernation and suspend modes
- Supports Windows XP®, Windows Vista®(32/64 bits), Windows 7®(32/64 bits)

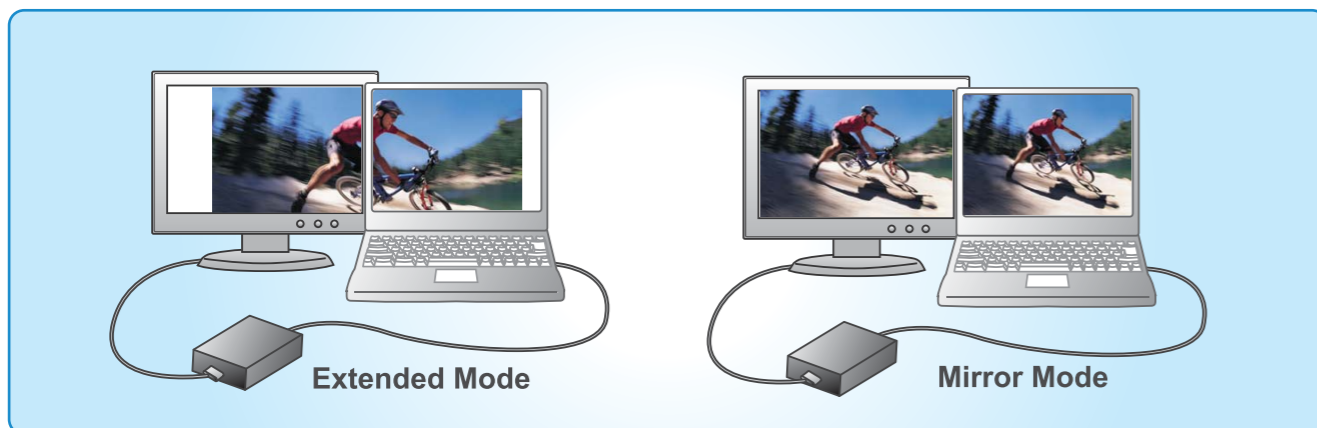

HDMI® to VGA Adapter (with Audio)



- On-chip HDMI® receiver with Equalizer
- On-chip HDMI® Receiver core which is compliant with HDMI® 1.2a specification
- Supports analogue video output up to 1080p
- Low stand-by current at power down mode
- On-chip Audio Decoder which support 2-channel and S/PDIF audio outputs
- Support audio soft mute Button
- Support Audio Jack
- Provide USB to DC power cable
- No need driver installation
- Supports Windows® XP, Windows Vista®, Windows 7®, Android



HDMI® to VGA Adapter



- On-chip HDMI® receiver with Equalizer
- On-chip HDMI® Receiver core which is compliant with HDMI® 1.2a specification
- Supports analogue video output up to 1080p
- Low stand-by current at power down mode
- Different HDMI connector type for selection
- No need driver installation
- Supports Windows® XP, Windows Vista®, Windows 7®, Android

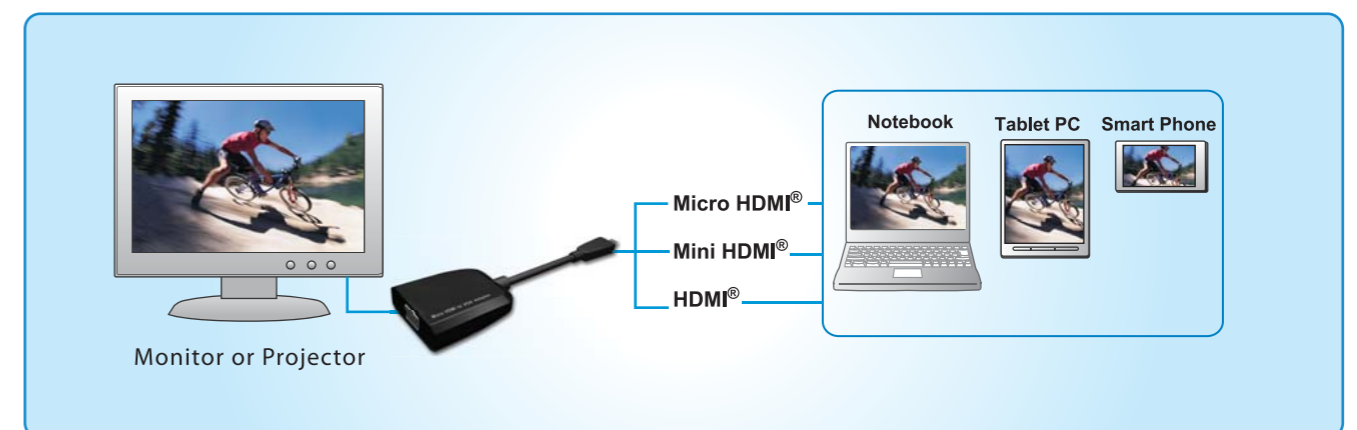

AN2700

Multimedia Sharing Adapter

- Access high-definition video files in PC directly through Multimedia Sharing Adapter
- Easy Plug and Play feature and automatically load onto your system
- High data transfer rate allows you easily to play 1080p HD video file
- Support many High Definition broadcasting products which the USB host/OTG built-in, such like HDTV, BD player, media player
- Supports Windows® XP, Windows Vista®, Windows 7®



DisplayPort Adapter



AY1210

DP to HDMI® With Audio Adapter (Active Solution)

- Active solution and it supports AMD eyeinfinity to help extend three screens to satisfy gaming use
- No extra drivers need when it plugs
- Support Plug & Play for easy use
- Resolution is up to 1920 x 1200
- Support 2-channel audio function
- HDMI® 1.3a compliant transmitter supporting 10/12-bit deep color 1080p up to 2.25 Gbs
- Support Windows XP®, Windows Vista®, Windows 7®



AY2210 (mini DP)

Mini DP to HDMI® With Audio Adapter

- No extra drivers need when it plugs
- Support Plug & Play for easy use
- Mini DP to HDMI® with resolution till 1920x1200
- 2 channel Audio function
- Compliant with HDMI® 1.3a
- Support Windows XP®, Windows Vista®, Windows 7® and Mac®



AY1100



AY1100
AY1110
(Active Solution)



AY2100(mini DP)

DP to DVI Adapter (Active Solution)

- DisplayPort to DVI adapter(AY1100)
- mini DisplayPort to DVI adapter(AY2100)
- Glossy white & elegant outlook design
- Bundled with 15cm cable is more easily to use
- Compliance with DisplayPort Specification V1.1a
- Support up to 1080p and 1920*1200@60Hz
- Support bit depth per color with 6/8/10 bits
- Active Solution (AY1110 only) compatible with VESA standard
- Supports Windows XP®, Windows Vista®, Windows 7®, Mac®



AY1000



AY2000(mini DP)

DP / mini DP to VGA Adapter

- DisplayPort to VGA adapter(AY1000)
- mini DisplayPort to VGA adapter(AY2000)
- Glossy white & elegant outlook design
- Bundled with 15cm cable is more easily to use
- Compliance with DisplayPort Specification V1.1a
- Support up to WUXGA (1920X1200) and UXGA (1600x1200) VESA display format
- Support bit depth per color with 6/8/10 bits
- Supports Windows XP®, Windows Vista®, Windows 7®, Mac®



AY1200



AY2200(mini DP)

DP / mini DP to HDMI® Adapter

- DisplayPort to HDMI® adapter(AY1200)
- mini DisplayPort to HDMI adapter(AY2200)
- Glossy white & elegant outlook design
- Bundled with 15cm cable is more easily to use
- Compliance with DisplayPort Specification V1.1a
- Support up to 1080p and 1920*1200@60Hz
- Support bit depth per color with 6/8/10 bits
- Supports Windows XP®, Windows Vista®, Windows 7®, Mac®

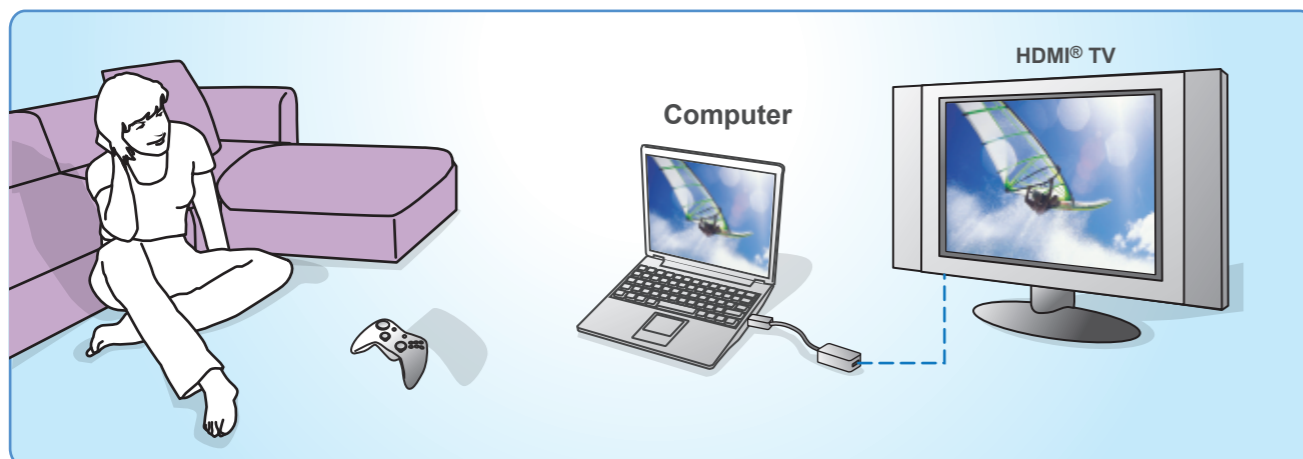

2D to 3D Converter (4 to 1)



VT7040

- 2D to 3D content converter
- Support 4 HDMI® sources input and 1 HDMI® output
- Select source and functions control using remote control
- With 3D depth adjustment function
- Resolution auto upscaling as source from 720p to 1080p and image enhancement
- It adapts with 3D TV or 3D projector for content playing
- It provides POP and Depth adjustment function for 3D content

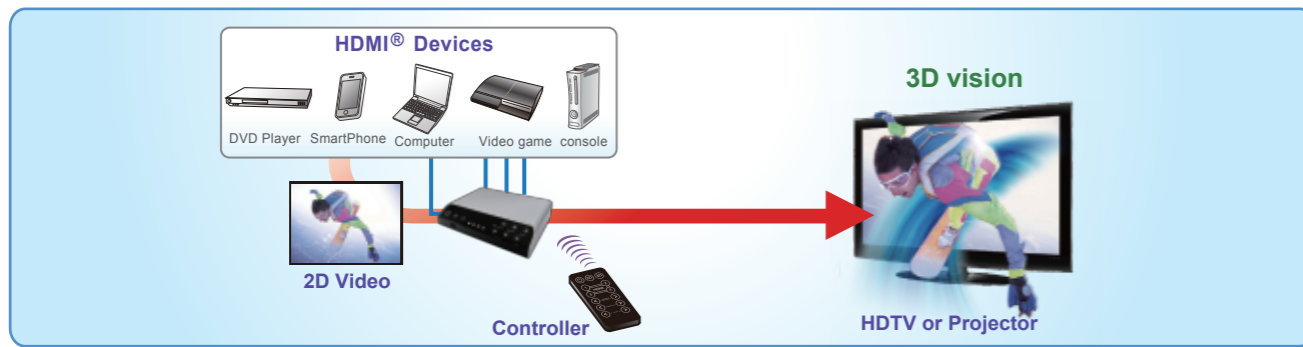

2D to 3D Converter (1 to 1)



VT7010

- 2D to 3D content converter
- Support 1 HDMI® source input and 1 HDMI® output
- With 3D depth adjustment function
- Resolution auto upscaling as source from 720p to 1080p and Image enhancement
- Adapts with 3D TV or 3D projector for content playing
- 2D to 3D pop function for screen pulls in and pulls out.



MHL to HDMI® Adapter (with remote function)



VS4710

- Support MHL to HDMI® specification
- Support MHL / HDMI® auto detection on input port.
- Support up to 75 MHz pixel clock rate (8-bit 1080i/720p 60Hz/ 1080p 60Hz) for MHL input.
- Low stand-by current (<1mA) at power down mode
- Provide charging function to smart phone
- Support RCP(mobile phone) / CEC(TV) converting function.
- By remote controller to operate mobile phone function by TV screen
- Support 3D (Side-by-Side Horizontal and Top-and-Bottom) content transmission via this adapter
- Support HDCP content pass through to HDTV

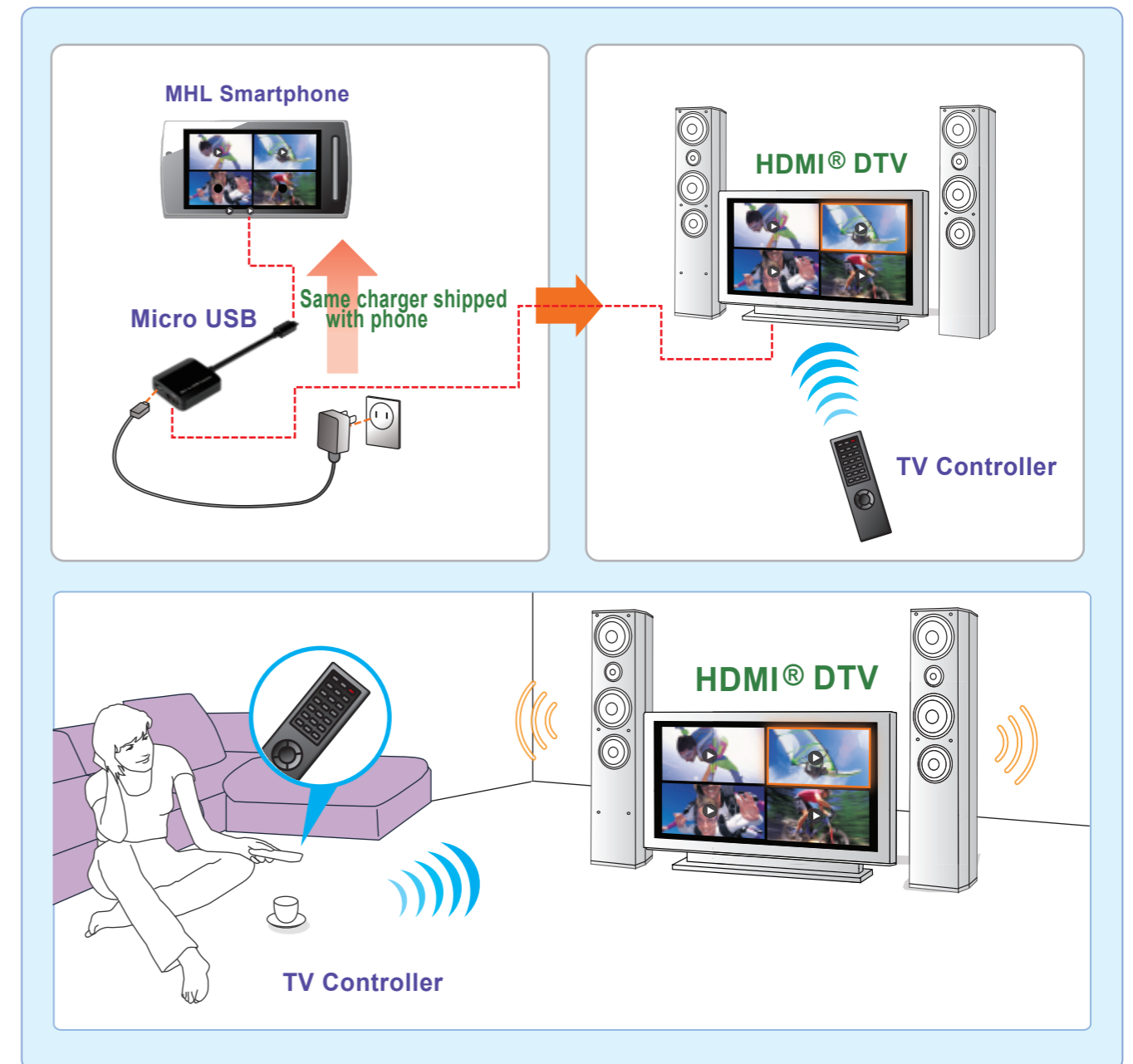

USB Peripherals

USB 3.0

USB 3.0 Products List

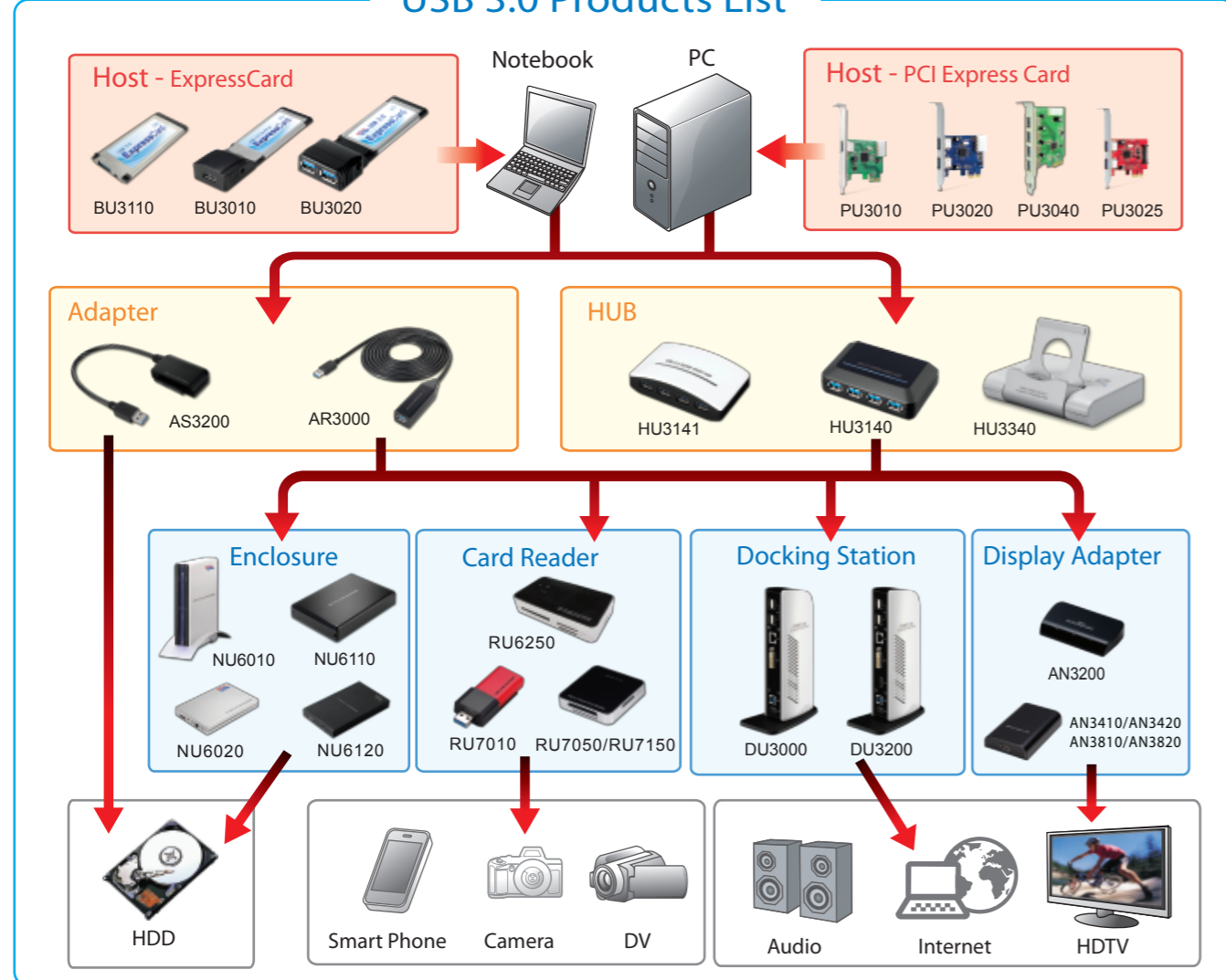

USB 3.0 / 2.0 Charging Hub

- Compliance with USB 2.0 / 3.0 (HU3340 only)
- Compliance with USB 2.0 (HU2Y40 / HU2Y41 only)
- Internal power failure detection for ESD recover
- With 1 USB charging port supports BC1.2 fast charging feature (HU2Y40 / HU3340 only)
- With 2 USB charging ports support BC1.2 fast charging feature (HU2Y41 only)
- Charging feature supports up to 2.1 A for one USB charging port
- With one port DCP/CDP mode switchable design to support data sync and charging feature
- Supports Windows XP®, Windows Vista®, Windows 7®, Mac®

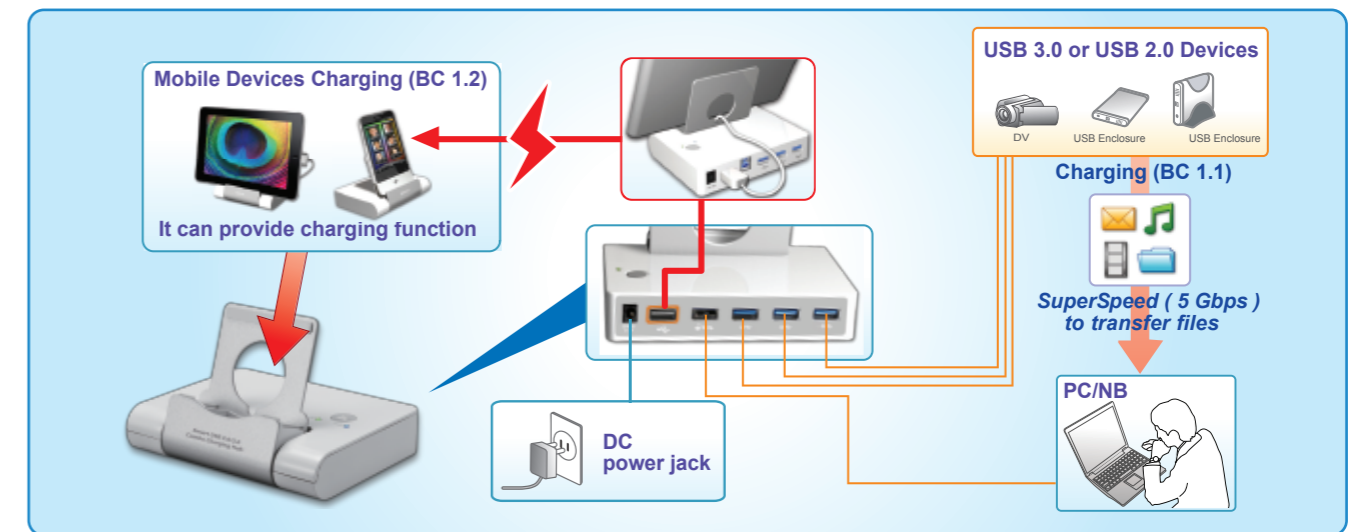

AN3200

USB 3.0 Dual Head Display Adapter

- Compliant with USB 3.0/2.0 specification
- Resolution up to 2048 x 1152
- Dual head display with HDMI® and DVI-I output
- Support HDMI® v1.3
- Support Windows XP®, Windows Vista® (32/64 bits), Windows 7® (32/64 bits)



USB 3.0 Display Adapter

- Add-on monitor, LCD or projector through a Different display output
- Compliant with USB 3.0 Super Speed (Data Rate 5Gbps) upstream connection
- Maximum resolution support : 2048x1152 / 2560x1600 (DP only) pixels
- Variety of display output interface including VGA / DVI / HDMI® / DP
- USB bus-powered
- Supports Windows XP®, Windows Vista®(32/64 bits), Windows 7®(32/64 bits)





USB 3.0 to SATA 3.5" Enclosure

- Compliant with USB 3.0/2.0/1.1
- Compliant with SATA II 1.0
- Supports : 3.5" SATA / SATA II HDD
- Supports SATA II Hot Plug and Plug-and-Play
- I/O Port : 1 x USB 3.0 Type B Female Connector
- Supports Windows XP®, Windows Vista®, Windows 7®



(NU6010)
TID #310000021
(NU6110)
TID #310720093

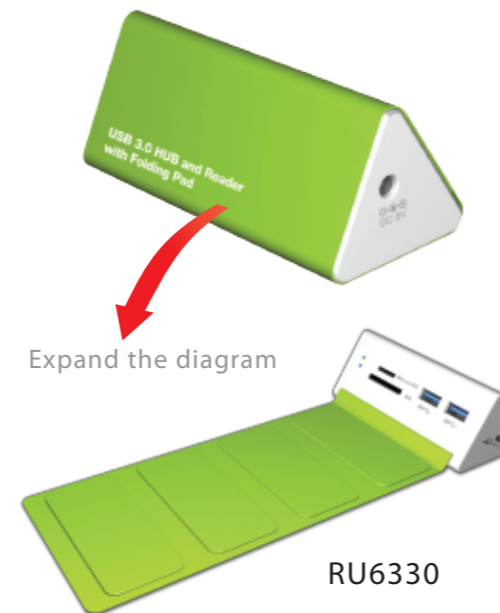

USB 3.0 HUB and Reader with Folding Pad

- Protected cover design to position portable devices on the cover without any damage
- With flexible rolled protected cover design to let user easily wrap up
- Support USB 3.0 2 ports hub with compatible BC1.1 when back use as USB 2.0 function
- Each port provides max 1.5A capacity when use BC1.1 charging function. The total capacity is 2.5A
- Support Micro SD and SD readers to let users multi-use for portable devices need
- Support Windows XP®, Windows Vista®, Windows 7®



USB 3.0 to SATA 2.5" Enclosure

- Compliant with USB 3.0/2.0/1.1
- Compliant with SATA II 1.0
- Supports : 2.5" SATA / SATA II HDD
- Supports SATA II Hot Plug and Plug-and-Play
- Save Remove Button (NU6020 only)
- Supports Windows XP®, Windows Vista®, Windows 7®



(NU6020)
TID #310000019
(NU6120)
TID #310720058



USB 3.0 Multi Card Reader with Charging HUB Combo

- USB 3.0 4-in-1 Card Reader support CF/SD/MS/MMC/T-Flash
- It intergraded USB 3.0 2-port Hub and USB 2.0 port charging function to 2A for mobile device
- Support for F/W upgrade via USB port
- Multi Transaction architecture to guarantee Full speed data passing bandwidth
- Backward compatible with USB 2.0/USB 1.1
- Support Windows XP®, Windows Vista®, Windows 7®



USB 3.0 Card Reader Single Slot (SD)

- Compliant with USB 3.0 and 2.0 specification
- Super Speed transfer rate at 5 Gbps
- Single slot to read:
 - SD / Mini SD / Micro SD (T-Flash)
- Support USB 2.0/USB 3.0 power saving modes
- Support SDHC & SDXC
- Support Windows XP®, Windows Vista®, Windows 7®



RU7050 (5 in 1)



RU7150 (4 in 1)

USB 3.0 Card Reader Multi Slot

- Compliant with USB 3.0 and 2.0 specification
- Super Speed transfer rate at 5 Gbps
- Support SD/MMC slot and SD/MS/MMC slot copy correspondently (RU7050 only)
- Support Card Reader to read:
 - Compact Flash
 - Secure Digital (SD), SDHC, SDXC, Mini SD, Micro SD (T-Flash)
 - Multi Media Card (MMC), RS-MMC, MMC Micro, MMC Mobile
 - Memory Stick (MS), Memory Stick DUO (MS DUO), High Speed Memory Stick (HS MS), Memory Stick Pro (MS PRO), Memory Stick Pro Duo, Memory Stick Pro-HG, MS Pro Micro, Memory Stick XC, Micro-MS(M2)
- SM (RU7050 only)
- USB bus-powered operation
- Support USB 2.0/USB 3.0 power saving modes
- Support CF5.0
- Support SDHC & SDXC
- Support Windows XP®, Windows Vista®, Windows 7®





USB 3.0 ExpressCard

- Adds 1/2 External Type A USB 3.0 ports to your device
- Super Speed Transfer rate at 5 Gbps
- 10 times faster than USB 2.0
- Installs easily into any Express Card
- Hot Swappable - Plug-n-Play
- Fully backwards compatible with USB 2.0, 1.1
- Supports Windows XP®, Windows Vista®, Windows 7®

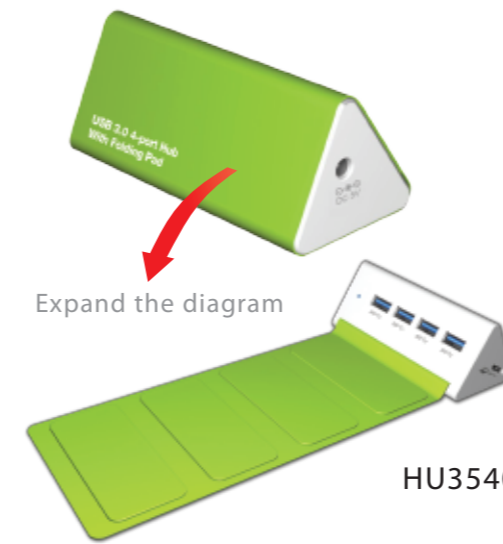

USB 3.0 4-port Hub with Folding Pad

- Protected cover design to position portable devices on the cover without any damage.
- With flexible rolled protected cover design to let user easily wrap up.
- Support USB 3.0 4 ports hub with compatible BC1.1 when back use as USB 2.0 function
- Each port provides max 1.5A capacity when use BC1.1 charging function. The total capacity is 4A
- Support Windows XP®, Windows Vista®, Windows 7®

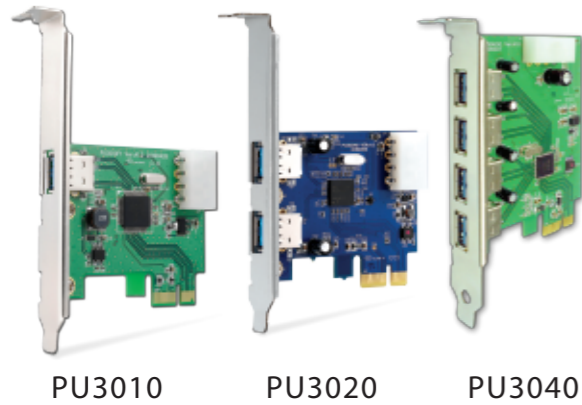

USB 3.0 PCIe Card

- 1/2/4 External Type A USB 3.0 ports
- Super Speed Transfer rate at 5 Gbps
- 10 times faster than USB 2.0
- Installs easily into any PCI Express slot
- Plug-n-Play
- Available with on-board Molex power connector
- Fully backwards compatible with USB 2.0, 1.1
- Supports Windows XP®, Windows Vista®, Windows 7®



USB 3.0 to SATA Adapter

- Compliant with USB 3.0/2.0/1.1
- Compliant with SATA II 1.0
- Supports Super Speed data transfer rate at 5 Gbps
- Hot Swappable - Plug-n-Play
- DC plug to USB connector cable included to ensure full power is available for portable hard drives
- Supports 2TB over HDD
- Supports Windows XP®, Windows Vista®, Windows 7®



USB 3.0 SATA to PCIe Card

- 2 External Type A USB 3.0 ports
- Super Speed Transfer rate at 5 Gbps
- 10 times faster than USB 2.0
- Installs easily into any PCI Express slot
- Plug-n-Play
- Available with on-board SATA power connector
- Fully backwards compatible with USB 2.0, 1.1
- Supports Windows XP®, Windows Vista®, Windows 7®



USB 3.0 Active Repeater Cable (3 M)

- Active USB repeater cable, assuring signal quality and reliability
- Super Speed transfer rate at 5 Gbps
- Repeater cable length is 3 meter
- Connect to USB devices or 2nd active repeater cable
- Max. Transfer rate at 5Gbps
- Power mode: Bus-powered and self-powered mode
- Support Windows XP®, Windows Vista® and Windows 7®



USB 3.0 4-port Hub

- 4 USB 3.0 Super Speed ports for easy expansion
- Supports Super Speed data transfer rate at 5 Gbps
- Hot Swappable - Plug-n-Play
- Backward compatible with USB 2.0, 1.1 specifications
- Super Speed 3.0 HUB allows the sharing of the storage peripheral among many PCs through optimal Super Speed at 5 Gbps
- Power adapter included to ensure full power is available for high-power USB devices such as portable hard drives
- Supports Windows XP®, Windows Vista®, Windows 7®



USB 3.0 Cable

- Compliant with all USB 3.0/2.0/1.1 specification
- Certified grade high speed performance
- Cable Types : CU1FF - Type A/male-A/male
CU1FH - Type A/male-B/male
CU1FK - Type A/male-Micro B/male
- Cable length : (1M/1.8M/2M/2.4M)



CU1FF
(Type A/male-A/male)



CU1FK
(Type A/male-Micro B/male)



USB Peripherals 2.0



HU2SA0

USB 2.0 10-port Hub (12 M)

- Reliable transmission to 12 m maximum
- 10-port USB 2.0 hub
- The rotation ports allows users to adjust direction of wireless devices
- Compliant with USB 2.0 specification (Data Rate 1.5/12/480 Mbps)
- Over-current detection and protection
- Supports Windows XP®, Windows Vista®, Windows 7®, Mac®



HU2024

HU2044

USB 2.0 2 / 4-port Hub

- Easy to extend I/O ports for PC
- Compatible with Universal Serial Bus Specification Revision 2.0 (Data Rate 1.5/12/480 Mbps)
- Connects up to 127 USB Devices
- Bus-power mode, no need extra power adapter
- Plug-and-Play function
- Over-current detection and protection
- Supports Windows XP®, Windows Vista®, Windows 7®, Mac®



HU2W70

HU2U70

USB 2.0 7-port Hub (12 M)

- Supports Fast Charging BC1.1 (HU2W70 only)
- Reliable transmission to 12 m maximum
- 7-port USB 2.0 hub
- Compliant with USB 2.0 specification (Data Rate 1.5/12/480 Mbps)
- Over-current detection and protection
- Supports Windows XP®, Windows Vista®, Windows 7®, Mac®



180° rotated USB port

HE2230

USB 2.0 3-port Hub with Ethernet Adapter

- Compliant with IEEE 802.3 (10Base-T) and 802.3u(100Base-TX) standards
- Powered by USB port, No external power adapter required
- Compliant with USB 2.0 and USB 1.1 specifications
- Support both full-duplex and half-duplex operations

hub

- 1 upstream and 3 downstream USB ports
- Over-current detection and protection
- Compliant with USB 2.0 (Data Rate 1.5/12/480 Mbps)
- Plug and Play
- Supports Windows XP®, Windows Vista®, Windows 7®, Mac®



HU2X40

Wall Mount Charging 4-port Hub

- One LED indicates power on/USB port acting status
- It can plug in the wall socket without extra power adapter to meet charging directly.
- It can also through PC to run hub function when plug in wall socket or not
- Supports Windows XP®, Windows Vista®, Windows 7®, Mac®



HE2440

USB 2.0 4-port Hub with Ethernet Adapter

- Compliant with IEEE 802.3 (10Base-T) and 802.3u(100Base-TX) standards
- Powered by USB port, No external power adapter required
- Compliant with USB 2.0 and USB 1.1 specifications
- Support both full-duplex and half-duplex operations

HUB

- 1 upstream and 4 downstream USB ports
- Over-current detection and protection
- Compliant with USB 2.0 (Data Rate 1.5/12/480 Mbps)
- Plug and Play
- Supports Windows XP®, Windows Vista®, Windows 7®, Mac®



HU2V40

USB 2.0 4-port Hub (12 M)

- Supports USB I/F Battery Charging Spec. V.1.1 Fast Charging
- Reliable transmission to 12 m maximum
- 4-port USB 2.0 hub
- Compliant with USB 2.0 specification (Data Rate 1.5/12/480 Mbps)
- Over-current detection and protection
- Supports Windows XP®, Windows Vista®, Windows 7®, Mac®

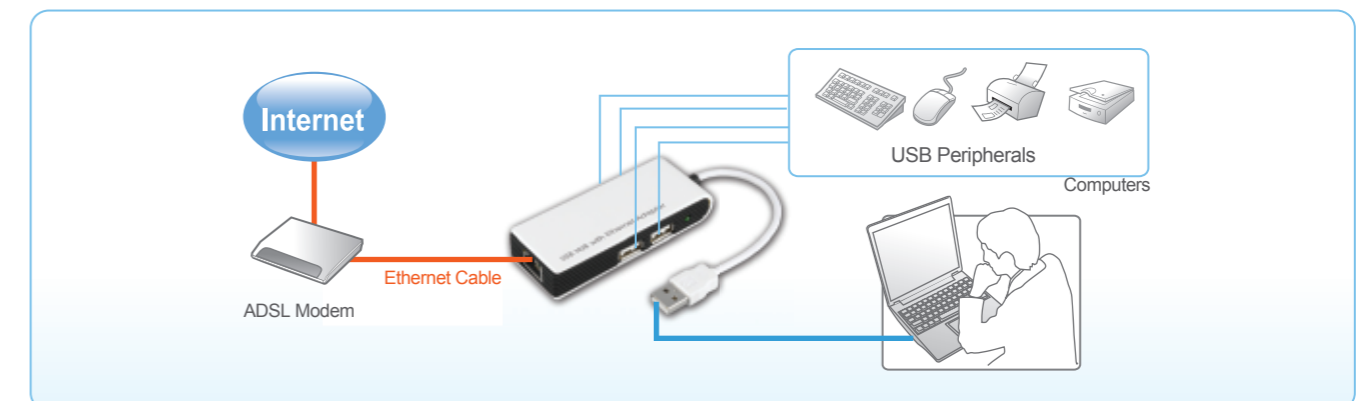

Accessories for Embedded Products

Wall Mount Charging Hub



HU2X40

- One LED indicates power on/USB port acting status
- It can plug in the wall socket without extra power adapter to meet charging directly.
- It can also through PC to run hub function when plug in wall socket or not.
- Distributed USB ports design make users selectable plug in different side of USB port
- Compliant with BC 1.2
- USB charge port for iPod/iPhone/iPad(2.1A)
- Supports Windows XP®, Windows Vista®, Windows 7®, Mac®



Wall socket

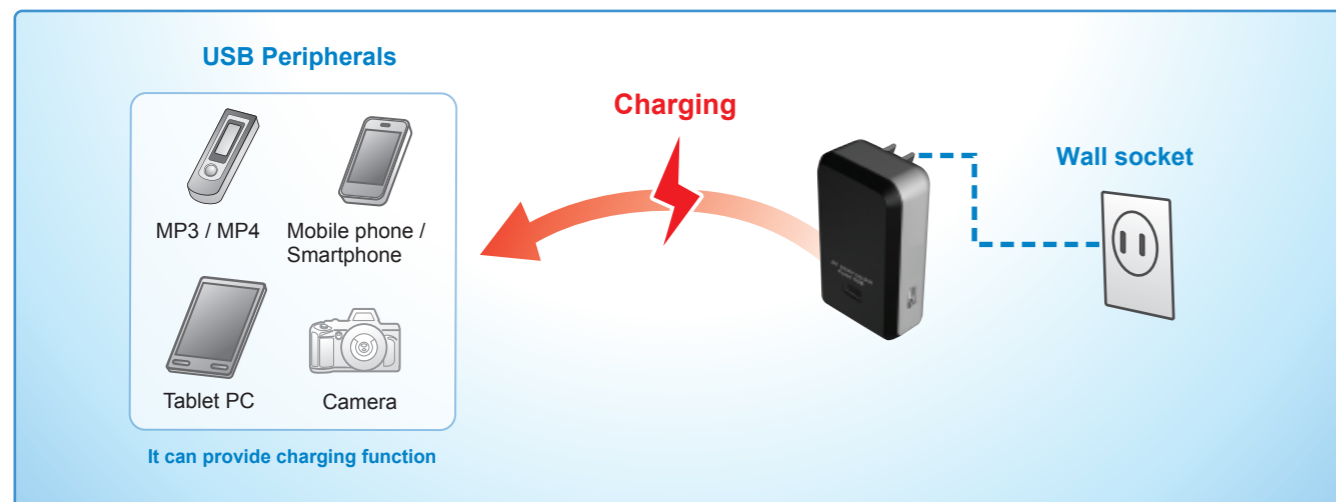
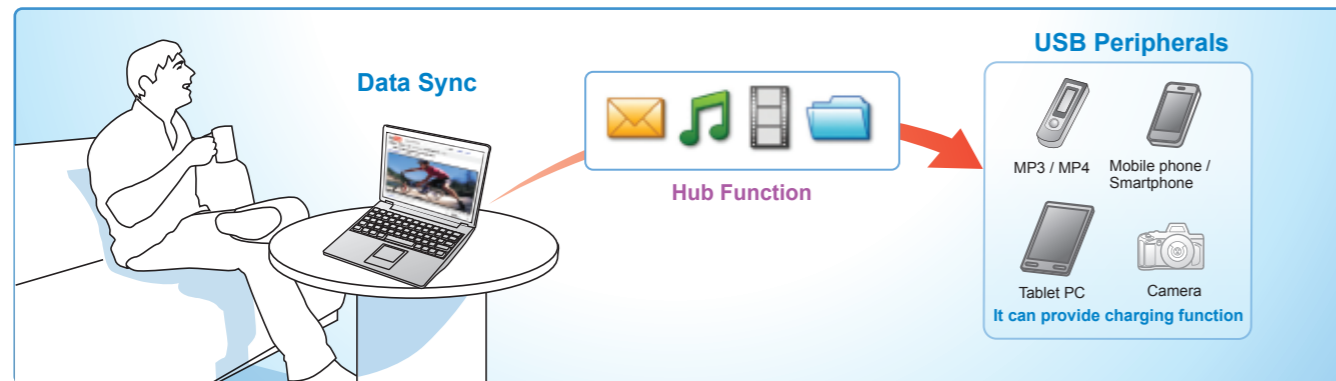

UP3700

Car Charger

- One led indicates power on/charging status
- Provide USB port via USB cable to connect any compatible USB device which needs charging in the car
- Up to 1.5A to meet more devices which needs high power charging
- DC 10-24V input/DC 5V/1.5A output

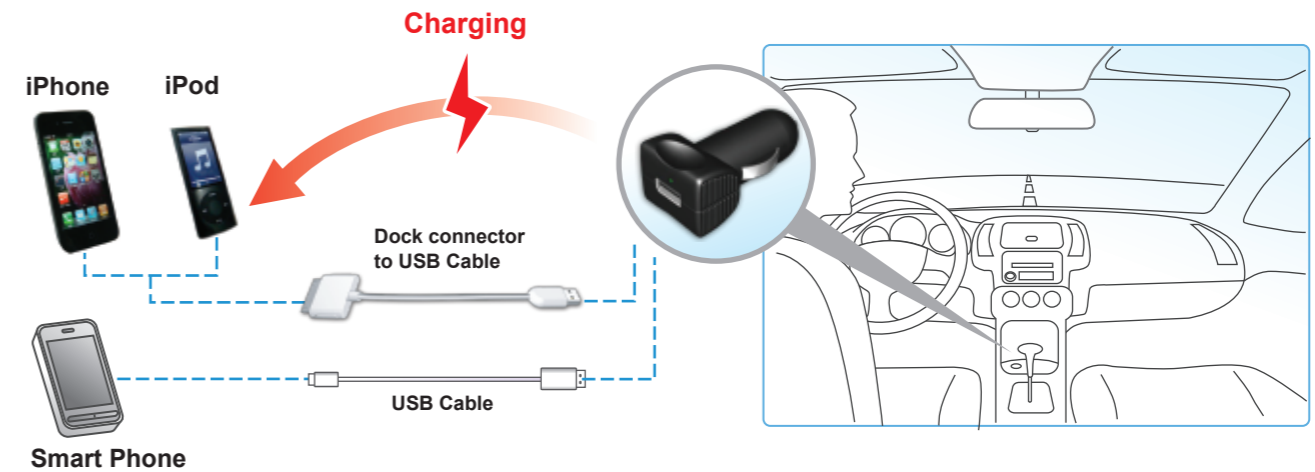

UP4000

USB Charging Adapter

- USB 1.1/2.0 compliant with charging only.

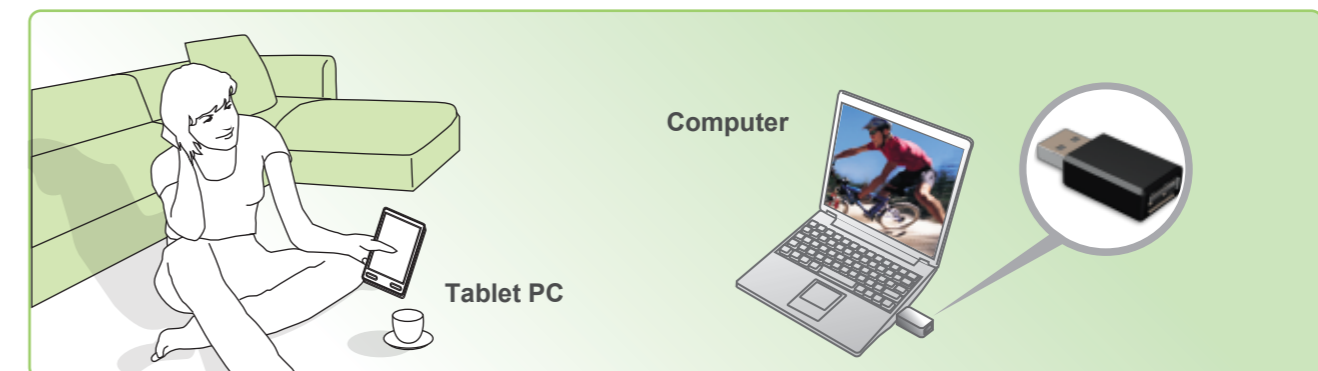
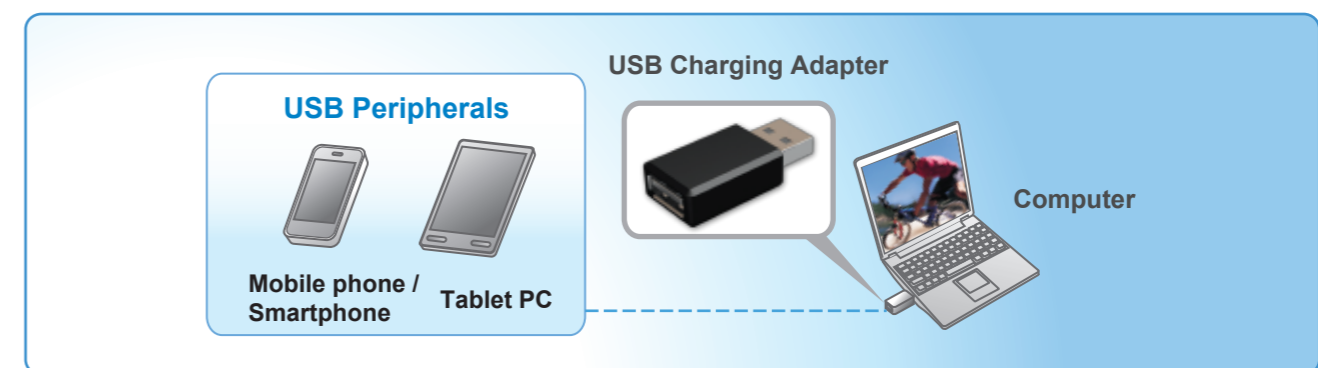

* iPod, iPhone, iPad are trademarks of Apple Inc.

File Transfer Adapter



AN2650

ODD Sharing Adapter

- To adapt CD burn-in program to burn in file to another PC CD-ROM Drive.
- To access CD-ROM Drive with OS re-install on another PC.
- To access CD-ROM Drive with application s/w on another PC.
- Above only supports PC windows base CD-ROM Drive. Plus support File transfer between two PCs with both windows base
- Supports Windows 2000®, Windows XP®, Windows Vista®, Windows 7®



AN2640

AN2641

High-Speed File Transfer Adapter

- Simple USB2.0 Plug-n-Play functionality
- Bi-directional data transfer between two computers or different operating systems
- No file size or media capacity limitations such as those found with external media cards
- EasySuite software program loads automatically
- Supports Windows XP®, Windows Vista®, Windows 7®, Mac® OS X v10.5 or later



Application I : Unlimited File Size Data Transfer



Application II : GoSuite- New Software Modules

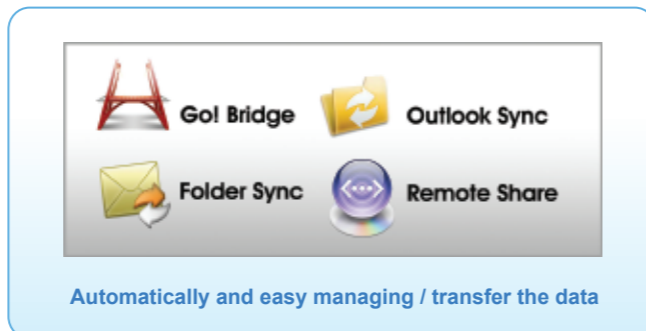

HU2P40(PC-to-PC)
HU2R40(PC-to-MAC)

Info TransHub

- Easy Plug and Play and automatically load onto your system
- Built-in 3 USB ports for HUB usage
- File Transfer function is compatible to use under Windows XP® SP2, Windows Vista®, Windows 7® and Mac® OS (HU2R40 only)
- HUB is compatible for Windows XP® SP2, Windows Vista®, Windows 7® or Mac® OS X v10.4 / OS X v10.5 or later
- For file or data transfer supports Windows 2000®, Windows XP®, Windows Vista®, Windows 7®



USB Link Adapter

- Fully compatible with High-speed USB 2.0
- Easy Plug and Play and automatically load onto your system
- Unlimited file size or media capacity limitations such as those found with external media cards
- New Go! Suite Software applications program loads automatically and easy manager / transfer the data
- Supports Windows XP®, Windows Vista®, Windows 7®



AN2620

USB Link Adapter

- Works with Windows Easy Transfer
- No additional driver and software required on Windows 7®
- Easy file sharing and data transfer between two PCs via USB port
- Supports Windows XP®, Windows Vista®, Windows 7®



AN2230

File Transfer & Info TransHub Product Comparison Table

Product No.	Model Name	S/W Support						Auto Install	Data Transfer Rate		OS	
		Easy Copy	Go! Bridge	Go! Finder	Folder Sync	Outlook Syne	Remote Share		Read (MB/sec)	Write (MB/sec)	WIN 7	MAC
AN2640	High-Speed File Transfer Adapter (PC-to-MAC/PC)	-	•	•	•	•	•	•	16	6	•	•
AN2641	High-Speed File Transfer Adapter (PC-to-MAC/PC)	-	•	•	•	•	•	•	16	6	•	•
AN2620	USB Link Adapter	-	•	-	•	•	•	•	16	6	•	-
AN2230	USB Link Adapter	-	•	-	-	-	-	-	16	6	•	-
HU2P40	Info TransHub (PC-to-PC)	•	-	-	-	-	-	•	16	6	•	-
HU2R40	Info TransHub (PC-to-MAC/PC)	-	•	-	•	•	•	•	16	6	•	•

RF Presenter



2.4GHz Presenter

- USB receiver stores conveniently inside the remote
- Up to 15 meters of wireless range
- Built-in laser pointer
- Compatible with most presentation applications including Microsoft PowerPoint, Keynote, Open office and Staroffice
- Supports Windows XP®, Windows Vista®, Windows 7®, Mac®

WM2210

Digital Audio Device

USB 7.1 CH Sound Box



AA1570

- Dramatically improve your PC / Computer / Notebook audio quality
- Auxiliary inputs for S/PDIF, microphone, stereo, and other analog sources
- Dolby digital audio streaming via S/PDIF out
- Virtual speaker shifter
- Volume up / volume down / playback mute / record mute HID button
- Full-duplex playback/recording audio stream without sound card in PC
- Supports Windows XP®, Windows Vista®, Windows 7®, Mac®

USB 5.1 CH Sound Box



AA1500

- Small size, convenient and portable
- Easily add sound to any Computer/Notebook
- USB bus-power, no external power required
- Auxiliary inputs for microphone, stereo, and other analog sources
- 5.1 CH surround sound technology over USB cable
- Dramatically improve your PC audio quality
- Provides home-theater quality surround
- Volume controlled through your computer or by manually on the adapter
- Simple to install plug-and-play operation for PC and Mac
- Supports Windows XP®, Windows Vista®, Windows 7®, Mac®

USB 5.1 CH Sound Box



AA1504

- Small size, convenient and portable
- Easily add sound to any Computer/Notebook
- USB bus-power, no external power required
- Auxiliary inputs for microphone, stereo, and other analog sources
- 5.1 CH surround sound technology over USB cable
- Dramatically improve your PC audio quality
- Provides home-theater quality surround
- Volume controlled through your computer or by manually on the adapter
- Simple to install plug-and-play operation for PC and Mac
- Supports Windows XP®, Windows Vista®, Windows 7®, Mac®

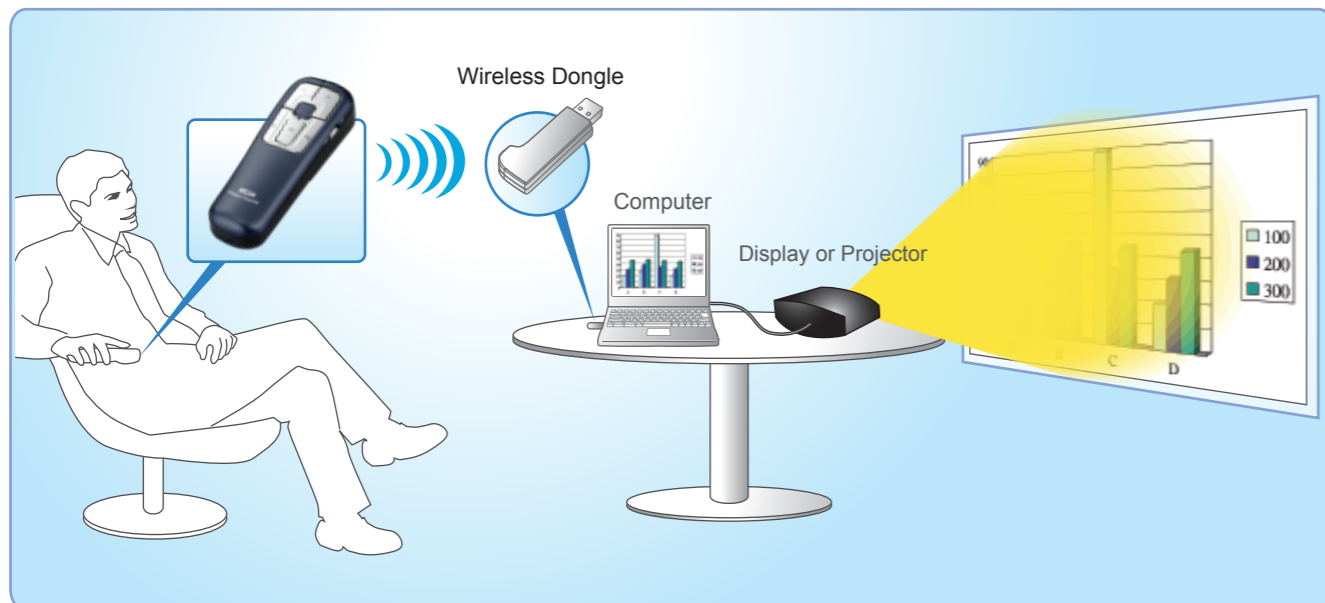
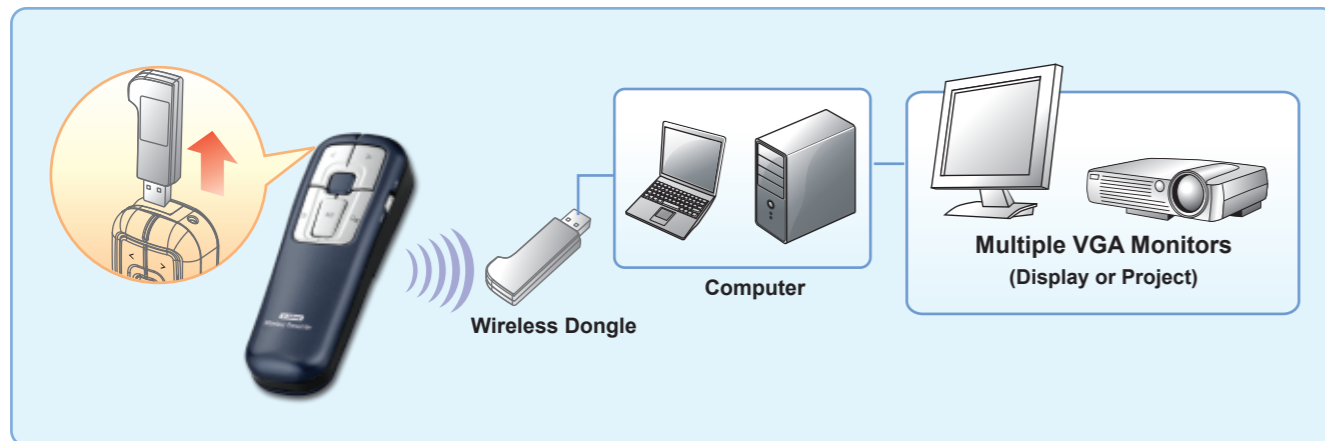

USB Share Switch



SS2115(2 to 1)
SS2155(4 to 1)

USB Share Switch

2 to 1

- 2 PCs to 1 USB device
- PC selected by double click Scroll Lock on keyboard
- Support Bus-powered only
- 100(L) x 81(W) x 29(H) mm
- Supports Windows XP® / Windows Vista®, Windows 7®

4 to 1

- 4 PCs to 1 USB device
- PC selected by double click Scroll Lock on keyboard
- Support Bus-powered only
- 100(L) x 81(W) x 29(H) mm
- Supports Windows XP®, Windows Vista®, Windows 7®



SS2320

USB 2 to 2 Share Switch Station

- 2 PCs share two USB devices (2x2)
- Built-in 2-port USB Switch
- Software and manual selectable connection
- Simple button operation
- Built-in auto-printer Switch Function
- Supports Windows XP®, Windows Vista®, Windows 7®

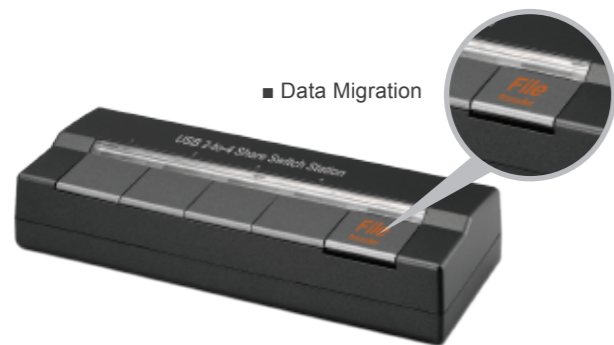

SS2340

- Data Migration

USB 2 to 4 / 6 Share Switch Station

- Simple button operation
- Build in data transfer between two computers(SS2340)
- Fast transfer rate of up to 16MB/second(SS2340)
- Software an manual selectable connection system requirements
- 2 PCs share 2-4 USB devices
- Stable and consistent data speed
- Supports Windows XP®, Windows Vista®, Windows 7®



SS23A0

- Dedicated one PC, not for sharing

Automatically switch between PC and Netbook when connecting to USB devices.

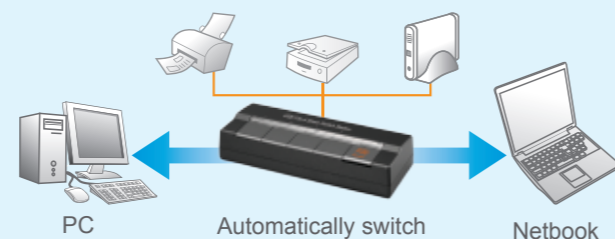

Adapter & Cable



AA1820

Composite AV Cable with USB

- Enables you to watch videos, photos and listen to music on your TV, Home theater receiver and stereo receiver through AV compatible equipment.
- Connect to your device via the 30-pin dock connector.
- USB provides charging function and data synchronization.
- Compatible with: Apple iPhone, iPod Nano, iPod Touch.

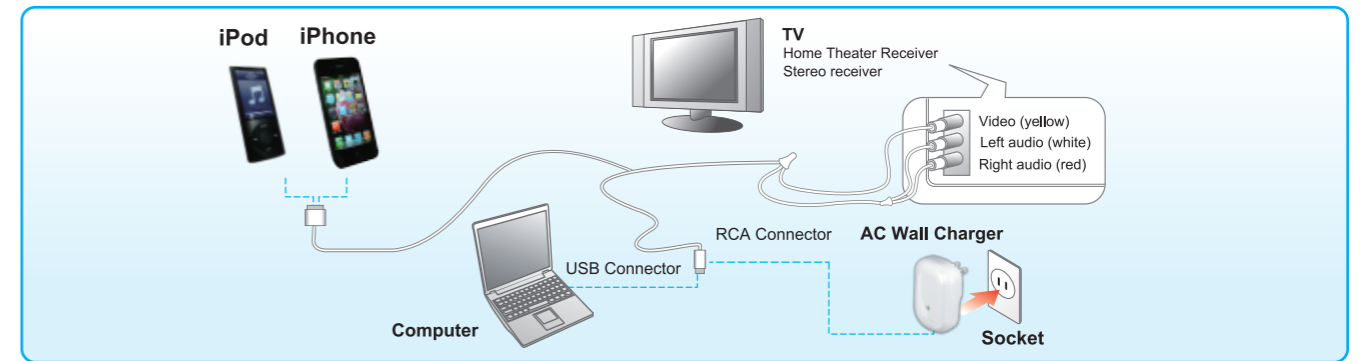

CU55Z3

Sync Cable

- Update music/data to your iPod, iPhone through this data cable
- Hot sync and charge your iPod, iPhone at the same time
- Synchronize & transfer your music files from your PC and Mac to your iPod, iPhone.
- This cable can also be connected to the iPod USB car charger/ Wall charger for charging on-the-go
- Compatible with: Apple iPhone, iPod classic, iPod Nano, iPod Touch
- Compatible with USB 1.1 & USB 2.0
- Supports Window 98, ME, 2000 32-bit, 2003 64-bit, XP 32/64-bit, Vista 32/64-bit and Mac 10.3 or later

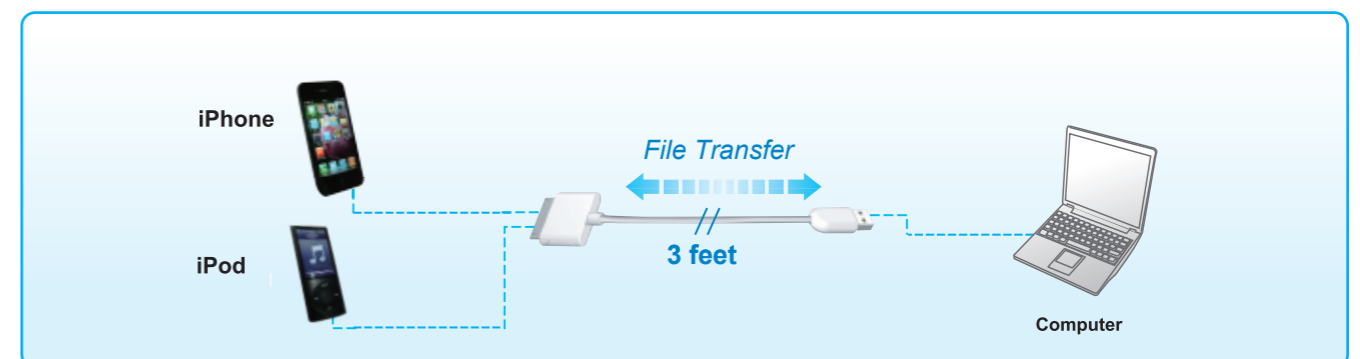

* iPod, iPhohne, iPad ard trademarks of Apple Inc.



AS1200

USB 2.0 to SATA/IDE Combo Adapter

- Compliant with SATA 1.0a and USB 2.0 specification
- Compliant with USB Mass Storage Class Bulk-Only Transport specification
- Dual-Head IDE connector (40Pin and 44Pin) plus one SATA connector support 2.5"/3.5"/5.25" IDE and SATA devices (a 2.5" to 3.5" IDE converter is required for 3.5" IDE drive)
- Supports Windows XP®, Windows Vista®, Windows 7®, Mac®



AP1305(36 pin)

USB to Parallel Adapter

- USB 1.1 type A male connector
- IEEE 1284 25/36 pin female connector
- Bi-directional communication
- Bus-powered
- Supports Windows XP®, Windows Vista®, Windows 7®

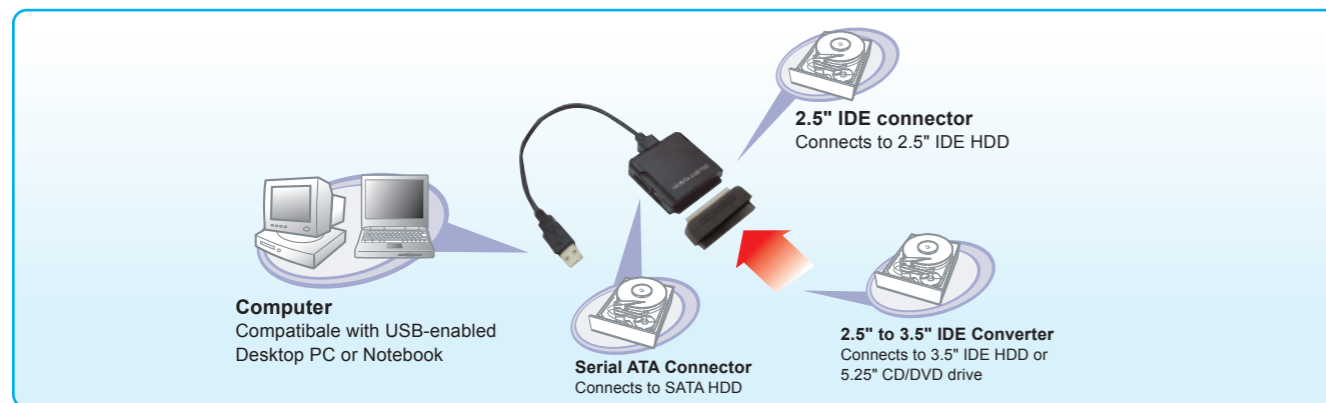

AR2510

USB 2.0 Active Repeater Cable (12 M)

- Active USB repeater cable, assuring signal quality and reliability
- Repeater cable length is 12 meter
- Connect to USB devices or 2nd active repeater cable
- Type A male to type A female
- USB bus powered
- USB2.0 and 1.1 compliant, work with both high, full and low speed USB devices
- Extend up to 60 meters by cascaded up to 4 repeater cable and 12M Hub(HU2V40)
- Supports Windows XP®, Windows Vista®, Windows 7®



AS2200

USB to SATA Adapter

- Connect to 2.5" & 3.5" SATA I and SATA II HDD
- Connect to 5.25" SATA I and SATA II DVD/Optical Drives
- Compliant with SATA II Specification 1.0;backward compatible with SATA I
- External power supply for 3.5" SATA HDD and 5.25" DVD/Optical Drives
- Supports Windows XP®, Windows Vista®, Windows 7®, Mac®

USB 2.0 Active Repeater Cable (5 M)

- Active USB repeater cable, assuring signal quality and reliability
- Repeater cable length is 5 meter
- Connect to USB devices or 2nd active repeater cable
- Up to 5 repeater cables can be cascaded to extend the distance
- Type A male to type A female
- USB bus powered
- USB2.0 and 1.1 compliant, work with both high, full and low speed USB devices
- Extend up to 25 meters by cascaded up to 5 repeater cable
- Supports Windows XP®, Windows Vista®, Windows 7®



AD3300

Serial ATA to IDE Converter

- Compliant with SATA 1.0 specification
- Support data transfer rate up to 150MB/s
- Supports Windows XP®, Windows Vista®, Windows 7®



AR2502



AP1103

USB to Serial Adapter

- USB 1.1 type A male connector
- Serial port DB 9 pin male connector
- Bus-powered
- Supports Windows XP®, Windows Vista®, Windows 7®, Mac®

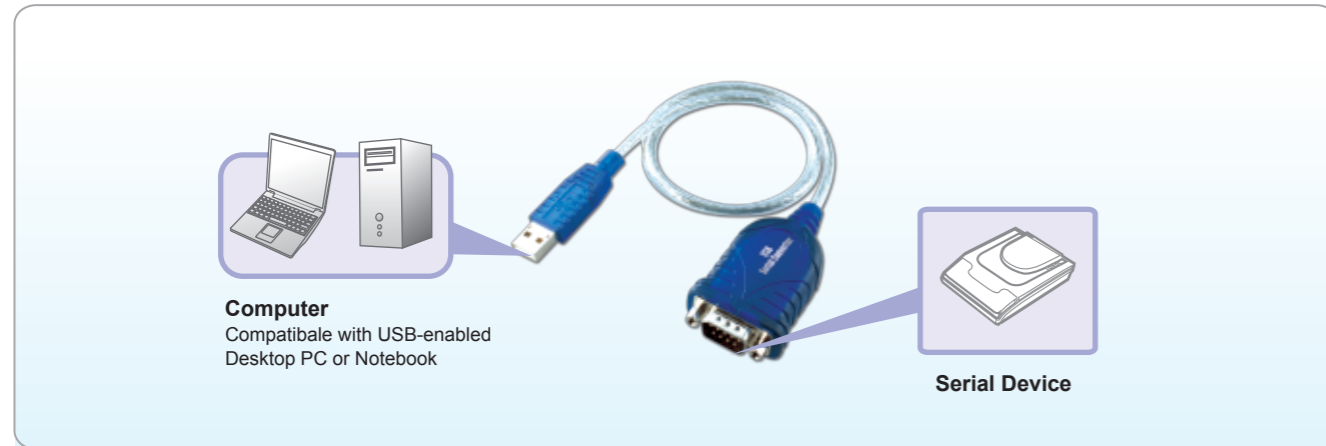

AP1200

AP1202

USB to PS/2 Adapter

- USB 1.1 type A male connector
- PS/2 mini Din 6 pin for keyboard and mouse
- Bus-powered
- Supports Windows XP®, Windows Vista®, Windows 7®, Mac®

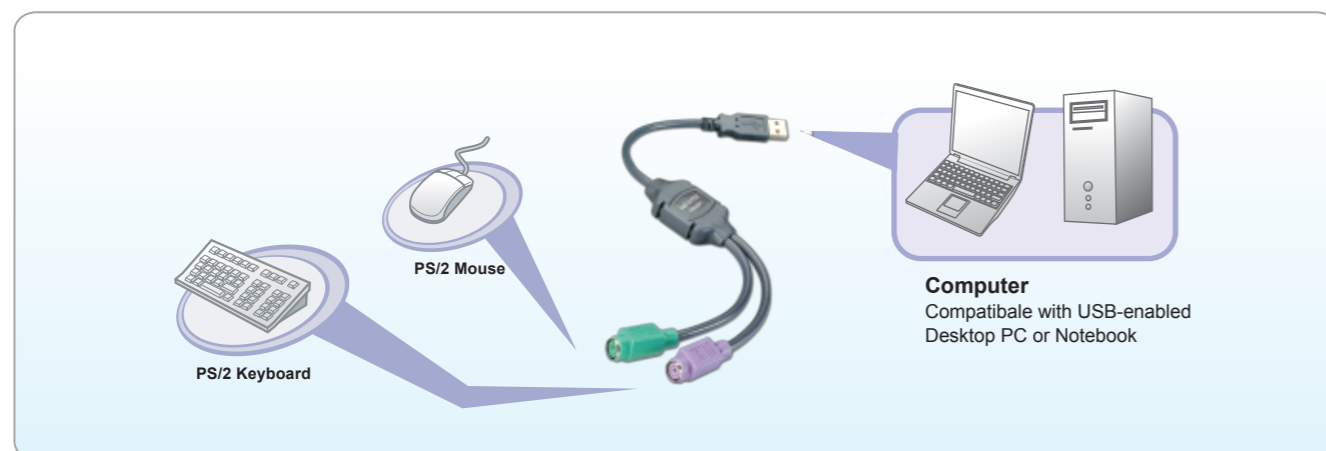

CD53K000



CD17Z000VGA



CD1HH



CD15G



CD1HL



CU15Z



CD166



CD144



CD155

CD53K000
DVI-D TO HDMI® ADAPTER
 ■ DVI-D 18P + 1P M
 ■ HDMI® 19P F

CD17Z000VGA
DVI-I FEMALE DUAL LINK TO VGA MALE ADAPTER
 ■ DVI-I 24P + 5P Female to VGA HDD 15 Pin Male

CD1HH
HDMI® MALE TO HDMI® CABLE
 ■ Increases bandwidth to 10.2Gbps(340Mhz)
 ■ Offers support for 16-bit color, increased refresh rates (ex.120Hz)
 ■ Support for 1440p/WQXGA resolutions

CD15G
DVI 24P + 1P MALE TO HDMI® MALE CABLE
 ■ Increases bandwidth to 10.2Gbps(340Mhz)
 ■ Offers support for 16-bit color, increased refresh rates(ex. 120Hz)
 ■ Support for 1440p/WQXGA resolutions
 ■ Pin to Pin compatible with DVI

CD1HL
HDMI® MALE TO MICRO HDMI® Cable
 ■ Support HDMI® v1.4
 ■ Increases bandwidth to 10.2Gbps (340MHz)

CU15Z
USB TO MICRO USB CHARGING CABLE

CD166
DVI-I (INTEGRATED) TO DVI-I DUAL LINK CABLE
 ■ DVI-I 24P + 5P Male to DVI-1 24P + 5P Male

CD144
DVI-I (INTEGRATED) TO DVI-I SINGLE LINK CABLE
 ■ DVI-I 18P + 5P Male to DVI-1 18P + 5P Male

CD155
DVI-D (DIGITAL) TO DVI-D DUAL LINK CABLE
 ■ DVI-D 24P + 1P Male to DVI-D 24P + 1P Male

WiFi / Wireless Products			
WK8000	WiFi Docking	1 x VGA, 1 x HDMI, 2 x USB 2.0, 1 x 10/100 LAN, 1 x Audio Jack	2
WA5000	DLNA Audio Box	2 CH Audio+3D Surrounding Box	2
FW2140	WiFi Docking	4 x USB 2.0, 1 x Power Terminal Connector, 1 x DIN Mount Kit, 1 x Antenna	3
FW2440	WiFi Serial Device Server	4 x LAN, 1 x Power Terminal Connector, 1 x DIN Mount Kit, 1 x Antenna	3
WK6102	WUSB Docking	1 x HDMI	4
WK6112	WUSB Docking	1 x HDMI	4
Wired Docking Station			
DU3000	Docking	2 x USB 3.0, 4 x USB 2.0, 1 x DVI, 1 x 10/100/1000 LAN, 1 x Mic, 1 x Audio Jack	5
DU3200	Docking	2 x USB 3.0, 4 x USB 2.0, 1 x DVI, 1 x HDMI, 1 x 10/100/1000 LAN, 1 x Mic, 1 x Audio Jack	5
DH2000	HDMI Docking	1 x HDMI, 4x USB 2.0, 1 x 10/100 LAN, 1 x Audio Jack, 1 x Mic	6
DU2800	Mini Docking	1 x DVI, 4x USB 2.0, 1 x 10/100 LAN	6
DU2810	Mini Docking	1 x DVI, 6x USB 2.0	6
DU27A2	Docking	1 x DVI, 4x USB 2.0, 1 x 10/100 LAN, 1 x Mic, 1 x Audio Jack	7
DU2792	Docking	1 x DVI, 4x USB 2.0, 1 x 10/100 LAN, 1 x Mic, 1 x Audio Jack	7
DU24A0	Docking	4 x USB 2.0, 1 x 10/100 LAN, 1 x Mic, 1 x Audio Jack, 1 x RS-232	7
HE2440	Portable Docking	4x USB 2.0, 1 x 10/100 LAN	7
Cloud Client			
ZC2600 (DU2600)	Docking	1 x VGA, 2x USB 2.0, 1 x Mic, 1 x Audio Jack	8
ZC2610	Docking	1 x VGA, 2 x PS2, 1 x Mic, 1 x Audio Jack	8
Network-Enabled Device			
AE6100 (A1/A2/A3)	Adapter	1 x HDMI, 2x USB 2.0, 1 x 10/100/1000 LAN	10
AE6210 (A1/A2/A3)	Adapter	1 x DVI, 2x USB 2.0, 1 x 10/100/1000 LAN, 1 x Audio Jack	10
AE3302	Adapter	1 x 10/100/1000 LAN	11
AE2220	Adapter	1 x A-Type USB	12
AE2230	Adapter	1 x A-Type USB	12
AE2240	Adapter	1 x Mini USB	12
AE2250	Adapter	1 x Micro USB	12
AE2201	Adapter	10/100 LAN	12
AE2302	Adapter	1 x 10/100/1000 LAN	12
AE2300	Adapter	1 x 10/100/1000 LAN	12
AE2302	Adapter	1 x 10/100/1000 LAN	12
Versatile Display Adapter			
AN3200	Adapter	1 x HDMI, 1 x DVI-I	13
AN3410	Adapter	1 x VGA	13
AN3420	Adapter	1 x DVI	13
AN3810	Adapter	1 x HDMI	13
AN3820	Adapter	1 x DP	13
AN2820	Adapter	1 x HDMI	13
AN2800	Adapter	1 x HDMI	13
AN2450	Adapter	1 x DVI	14
AN2460	Adapter	1 x DVI	14
AN2480	Adapter	1 x VGA	14
AN2485	Adapter	1 x VGA	14
AN2700	Link	1 x USB 2.0	14
VS4530	Adapter	1 x D-Type HDMI	15
VS4531	Adapter	1 x C-Type HDMI	15
VS4532	Adapter	1 x A-Type HDMI	15
VS4520	Adapter	1 x D-Type HDMI	15
VS4521	Adapter	1 x C-Type HDMI	15
VS4522	Adapter	1 x A-Type HDMI	15
DisplayPort Adapter			
AY1210	Converter	1 x HDMI with Audio	16
AY2210	Converter	1 x HDMI with Audio	16
AY1100	Converter	1 x DVI	17
AY1110	Converter	1 x DVI	17
AY2100	Converter	1 x DVI	17
AY1000	Converter	1 x VGA	17
AY2000	Converter	1 x VGA	17
AY1200	Converter	1 x HDMI	17
AY2200	Converter	1 x HDMI	17
VT7040	Converter	4 x HDMI	18
VT7010	Converter	1 x HDMI	18
VS4710	Adapter	1 x HDMI	19

USB Peripherals - USB3.0			
AN3200	Adapter	1 x HDMI, 1 x DVI-I	20
HU3340	Hub	3 x USB 3.0 / 1 x USB 2.0	21
AN3410	Adapter	1 x VGA	21
AN3420	Adapter	1 x DVI	21
AN3810	Adapter	1 x HDMI	21
AN3820	Adapter	1 x DP	21
NU6010	Enclosure	3.5" x USB 3.0	22
NU6110	Enclosure	3.5" x USB 3.0	22
NU6020	Enclosure	2.5" x USB 3.0	22
NU6120	Enclosure	2.5" x USB 3.0	22
RU7010	Card Reader	SD	22
RU6330	Card Reader	2 x USB 3.0, Micro SD, SD	23
RU6250	Card Reader	2 x USB 3.0, 1 x USB 2.0, CF, SD, MMC, MS, T-Flash	23
RU7050	Card Reader	SD, MMC, MS, CF, SM, SD, MS Pro	23
RU7150	Card Reader	SD, MMC, CF, M2, T-Flash	23
BU3110	Express Card	1 x USB 3.0	24
BU3010	Express Card	1 x USB 3.0	24
BU3020	Express Card	2 x USB 3.0	24
PU3010	PCIe Card	1 x USB 3.0	24
PU3020	PCIe Card	2 x USB 3.0	24
PU3040	PCIe Card	4 x USB 3.0	24
PU3025	PCIe Card	2 x USB 3.0 to SATA	24
HU3141	Hub	4 x USB 3.0	24
HU3140	Hub	4 x USB 3.0	24
HU3540	Hub	4 x USB 3.0	25
AS3200	Adapter	1 x USB 3.0 to SATA	25
AR3000	Adapter	1 x USB 3.0	25
CU1FH	Cable	A-B	25
CU1FF	Cable	A-A	25
CU1FK	Cable	A-Micro B	25
USB Peripherals - USB2.0			
HU25A0	Hub	10 x USB 2.0	26
HU2W70	Hub	7 x USB 2.0	26
HU2U70	Hub	7 x USB 2.0	26
HU2X40	Hub	4 x USB 2.0 BC1.2	26
HU2V40	Hub	4 x USB 2.0	26
HU2024	Hub	2 x USB 2.0	27
HU2044	Hub	4 x USB 2.0	27
HE2230	Hub with Ethernet Adapter	3 x USB 2.0, 1 x 10/100 LAN	27
HE2440	Hub with Ethernet Adapter	4 x USB 2.0, 1 x 10/100 LAN	27
USB Peripherals - Charger Devices			
HU2X40	Hub	4 x USB 2.0 BC1.2	28
UP3700	Charger Adapter	1 x USB 2.0	29
UP4000	Charger Adapter	1 x USB 2.0	29
USB Peripherals - Transfer Adapter			
AN2650	Link	1 x USB 2.0 (PC to PC)	30
AN2640	Link	1 x USB 2.0 (PC to MAC)	30
AN2641	Link	1 x USB 2.0 (PC to MAC)	30
HU2P40	Hub+Link	3 x USB 2.0 (PC to PC)	31
HU2R40	Hub+Link	3 x USB 2.0 (PC to MAC)	31
AN2620	Link	1 x USB 2.0	31
AN2230	Link	1 x USB 2.0	31
USB Peripherals - RF Presenter			
WM2210	Presenter	1 x USB 2.0	32
USB Peripherals - Digital Audio Device			
AA1570	Adapter	1 x S/PDIF-in, 1 x S/PDIF-out, 1 x Headset-in, 6 x Audio Jack	33
AA1500	Adapter	1 x Mic, 1 x Linein, 3 x Audio Jack	33
AA1504	Adapter	1 x Mic, 1 x Linein, 3 x Audio Jack	33
USB Peripherals - Share Switch			
SS2115	Share Switch	1 x USB 2.0 (2 Pcs to USB device)	34
SS2155	Share Switch	1 x USB 2.0 (4 Pcs to USB device)	34
SS2320	Share Switch	2 x USB 2.0	34
SS2340	Share Switch	4 x USB 2.0	34
SS23A0	Share Switch	6 x USB 2.0	34

USB Peripherals- Adapter & Cable			
AA1820	Cable	Composite AV Cable With USB	35
CU5523	Cable	Sync Cable	35
AS1200	Adapter	2.5"/3.5" IDE/SATA	36
AS2200	Adapter	1 x SATA	36
AD3300	Converter	1 x IDE	36
AP1305	Adapter	1 x Parallela	37
AR2510	Adapter	1 x USB 2.0	37
AR2502	Adapter	1 x USB 2.0	37
AP1103	Adapter	1 x RS	38
AP1200	Adapter	2 x PS/2	38
AP1202	Adapter	2 x PS/2	38
CD53K000	Adapter	HDMI	39
CD172000	Adapter	VGA	39
CD1HH	Cable	HDMI	39
CD15G	Cable	HDMI	39
CU15Z	Cable	Micro USB	39
CD1HL	Cable	Micro HDMI	39
CD166	Cable	DVI-I	39
CD144	Cable	DVI-I	39
CD155	Cable	DVI-D	39

Index

